



*EVERLASTING  
COMPANY*



**TEKSAN**

WE DELIVER POWER TO THE WORLD



**WHENEVER YOU NEED  
POWER, WE ARE  
ALWAYS WITH YOU...  
SINCE 1994!**

Since 1994, Teksan has been delivering high quality tailormade solutions that are designed accordingly to your requirements with strong after-sales technical support and maintenance services anytime and anywhere you need uninterrupted power supply. When your company is moving further ahead rapidly on the road to success, you always feel our continuous support as your reliable power solutions partner.  
*Because Teksan is a member of your family...*





## IN TEKSAN "PEOPLE" COME FIRST...



**Our vision is to become one of the world's leading energy suppliers without compromising from the philosophy "people come first", the reliability and the quality of products by following up the standards and continuing our investments together with our competent and creative employees having adopted the importance of knowledge and technology.**

**T**eksan, who aims to deliver uninterrupted power solutions to the people through sustainable improvement and innovation, designs and installs high quality diesel, natural and biogas driven generator sets, mobile lighting towers, portable generator sets, cogeneration-trigeneration solutions and hybrid power systems that exceed the expectations of the customers.

For more than 25 years, thanks to its solid experience and engineering know-how, Teksan has been providing tailor-made power solutions that can efficiently operate even under the most challenging conditions for major international projects such as constructions, telecommunications, data centers, shopping centers, hotels, residential buildings, supermarkets, sport centers, mining facilities, hospitals, research centers, educational institutions and industrial plants all around the world.

Today, thanks to its high quality generator sets approved with international quality certifications which are made of world's top engine brands coupled to well know alternators to meet projects' requirements of different output ranges, and strong after-sales technical support and maintenance services in more than 130 countries, Teksan is always your reliable power solutions partner whenever and wherever you need.





# MILESTONES OF SUCCESS...



1994 1996 2000 2003 2004 2005 2007 2011 2012 2013 2014 2015 2016 2017 2018 2019

*Established under the name "Deniz Mühendislik Ltd. Şti." and began its activities.*

*Changed its name as Teksan Jeneratör Elektrik Sanayi ve Ticaret A.Ş.*

*Moved to Sancaktepe Plant. Power upper limit was increased from 2250 kVA to 3550 kVA.*

*Increased its product range upper limit from 880 kVA to 2250 kVA.*

*Moved to Sancaktepe Plant. Power upper limit was increased from 2250 kVA to 3550 kVA.*

*R&D Department has been established.*

*Produced the first national natural gas generator set of Turkey.*

*With its special project with 2x3125 kVA - 11 kV alternators, Teksan produced the biggest generator sets in Turkey until today.*

*Developed the first domestic production cogeneration systems of Turkey.*



*Teksan carried out the most comprehensive ERP project of the industry.*

*Teksan carried out the most comprehensive ERP project of the industry.*

*Realised the first trigeneration system project with 4x500 kW gas engine.*

*Teksan was named among the in TIM's "Top 1000 Exporters of Turkey" list.*

*Realised the first trigeneration system project with 4x500 kW gas engine.*



*Teksan Generator started Teksan Production System (TÜS).*

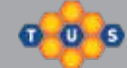

*Innovated the first national Hybrid Power System in Turkey.*

*Launched the power solutions that powered with biogas.*

*Increased the number of countries exported to 120.*

*Innovated the first national Hybrid Power System in Turkey.*



*Launched the power solutions that powered with biogas.*



*Kocaeli factory has started to operate.*

*Being recognised as a R&D Centre by the Ministry of Science, Industry and Technology, Teksan Generator has become the first private R&D centre in the industry.*

*Ranked Fortune 500 Turkey list from the 469th place.*

*Chosen for the TUBITAK-TEYDEB Success Stories Booklet with the first domestic Hybrid Generator Set of Turkey.*

*Launched the first and only "Hybrid Lighting Tower" of Turkey to its product range.*

*Ranked 436th in TIM 1000 and ISO 500 lists.*

*Moved up to the 97th place in the list of 250 leading R&D companies of Turkey.*

*Kocaeli factory has started to operate.*

*Being recognised as a R&D Centre by the Ministry of Science, Industry and Technology, Teksan Generator has become the first private R&D centre in the industry.*

*Ranked Fortune 500 Turkey list from the 469th place.*



*Chosen for the TUBITAK-TEYDEB Success Stories Booklet with the first domestic Hybrid Generator Set of Turkey.*

*Launched the first and only "Hybrid Lighting Tower" of Turkey to its product range.*

*Ranked 436th in TIM 1000 and ISO 500 lists.*

*Moved up to the 97th place in the list of 250 leading R&D companies of Turkey.*

*Awarded the Authorized Economic Operator (AEO) Certificate.*

*Has once again proved its quality and reliability by obtaining the UL Certificate.*

*Managed to enter the Turquality Brand Support Program.*

*Increased the number of countries exported to 130.*

*Awarded the Authorized Economic Operator (AEO) Certificate.*

*Has once again proved its quality and reliability by obtaining the UL Certificate.*

*Managed to enter the Turquality Brand Support Program.*

*Increased the number of countries exported to 130.*

*Celebrated Its 25th years in the industry. Teksan UK was established.*





# TEKSAN QUALITY IS NOT A COINCIDENCE!

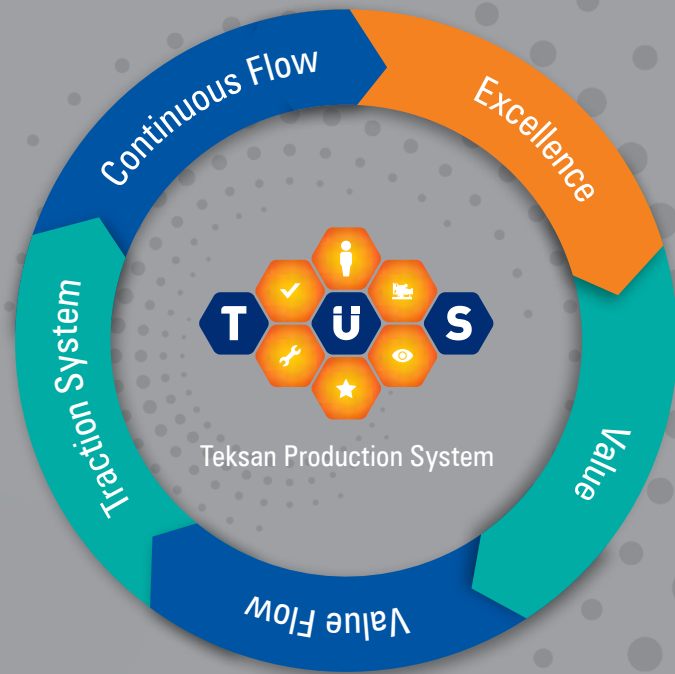

**T U S** Teksan Production System, which based on Lean Management philosophy, is whole of concept, system and techniques that have aim of the perfection in presented value by simplifying product and service creation process with offsetting wastage. Teksan Production System aims to increase customer satisfaction and get adaptation flexibility to market conditions with increasing quality and making it sustainable, reduction of costs, making the deliveries timely.

# TEKSAN'S HIGH STANDARDS!



## QUALITY CERTIFICATES AND DOCUMENTS



Producing high quality solutions with proper price that meets continuously-changing customer needs beyond expectations and delivering timely solutions are the most important objectives of Teksan's Quality Policy." In line with this aim, Teksan, which carries out all its activities with international standards, as well as Teksan Production System, Quality Management System, Environmental Management, Occupational Health and Safety system are established by Teksan, has lots of international certificates and documents as 2000/14/EC Noise Emission Certificate, ISO 9001, ISO 140001, SONCAP Product Certificate, OHSAS 18001, CE Certificate, GOST-R Certificate, TSE Service Competency Certificate and Turkish Standart Compliance Certificates, takes part among most reliable and most preferable companies of sector in power solutions with providing uninterruptedly pre-sales and after sales technical support.

## THERMAL ANALYSIS

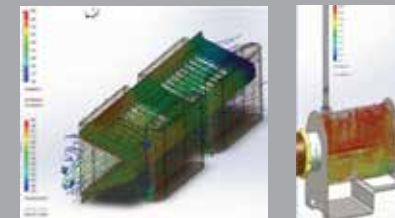

## FINITE ELEMENTS ANALYSIS

- Static Analysis,
- Dynamic Analysis,
- Natural Frequency Analysis,
- Fatigue Analysis,
- Nonlinear Analysis.

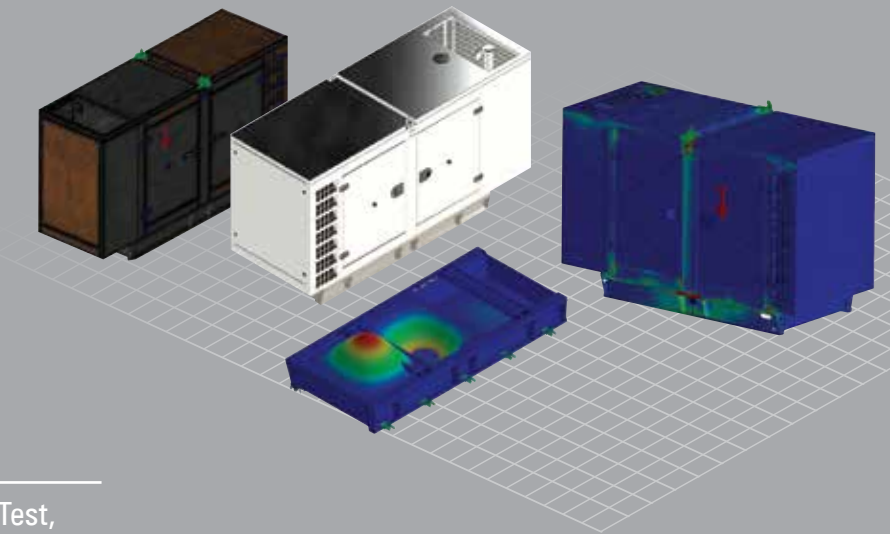

## TESTS

- Voltage Measurement, Implementations
- Vibration Test,
- Acoustic Test,
- Temperature Test,
- Performance Test.

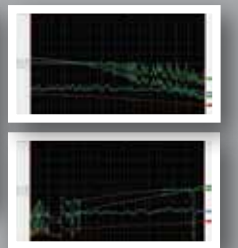
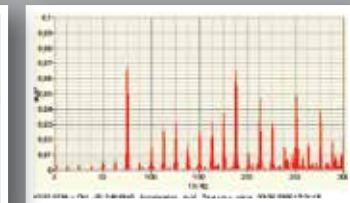

## COMPUTATIONAL FLUID DYNAMICS

- Cabin Flow Optimization,
- Exhaust muffler Back Pressure Analysis.

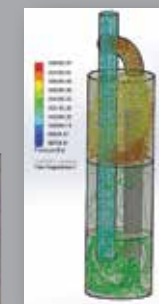

## ELECTRICAL TESTS

- Insulation Test,
- Working scenarios simulation,
- Harmonic Measurement,
- Temperature control.

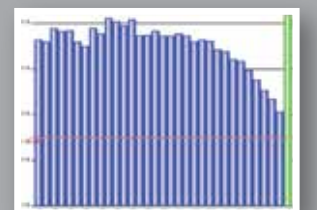

## LISTEN VERY CAREFULLY!

THANKS TO  
ULTRA SILENT CANOPIES,  
NOT ONLY YOUR GENSETS  
BUT ALSO YOUR EARS  
ARE PROTECTED!

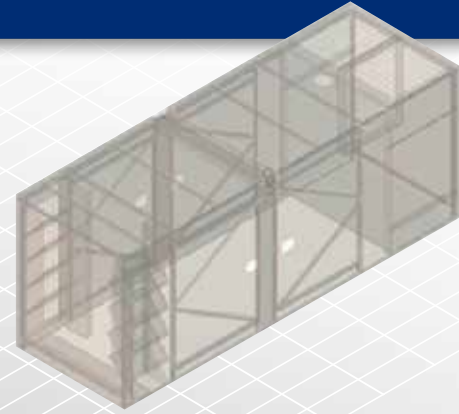

## STANDARD TYPE CANOPY

HIGH PROTECTION  
AGAINST  
CORROSION AND  
RUST

MAKING  
DIFFERENCE IN  
PERFORMANCE IN  
TERMS OF SOUND  
INSULATION

DESIGN  
WITH MAKING  
TRANSPORTATION  
AND MAINTENANCE  
EASIER

SAFE  
USAGE

- Compatible with 2000/14/EC directives, certified noise emission level,
- 2 or 4 points transport possibility according to cabin size,
- Hidden exhaust inside the canopy,
- Emergency stop button located on the canopy,
- Improved air suction channel to ensure homogenous cooling in the canopy,
- Radiator air outlet and exhaust with designed towards above,
- Lid on cab that provides to be filled up water and antifreeze easily to the radiator,

- Amplified paint system against corrosion and rusting,
- Improved performance in terms of sound insulation,
- Demounted parts that make transportation and maintenance easier,
- In accordance with customer requests, private canopy production with desired sound level/size.



## LIGHTING TOWERS

Lighting Towers, which are ideal for enlightening of construction sites, concrete works, road-bridge production works and outdoor organizations that are in open area and their usage places replace frequently, can also be produced with private sound level in accordance with customer requests.





## ALL CONTROL IS IN YOUR HANDS

### YOUR ENERGY IS UNDER "CONTROL"

**S**tandard control panels, that are used in Teksan sets, provide comfort and confidence in usage with all required indicators. Special control panels, that can satisfy all needs, are designed in accordance with requests of our customers.

#### AUTOMATIC CONTROL PANEL

Automatic Control Panel is designed according to generator groups that are used as back up of mains. It steps in automatically when mains electricity is cut and transfers the electricity that obtains from generator set to the system. In case of return of mains power, automatic control panel transfers the load to the mains and halts generator automatically. It has electronic control unit with protection and control specific and micro processor for working of engine and alternator group healthfully. As well as this unit gives a possibility to conn automatic-manuel-test at inert-test at load position, it also includes measurement equipments for visual control.

#### MANUEL CONTROL PANEL

Manuel Control Panel is designed for generator groups which are desired to connect manually. Especially, it is preferred in the absence of mains electricity power. Manuel control panel provides taking of protection precautions, monitoring and implementing of control operations. Micro processor electrical control module provides protection precautions.



## EXTENSIVE OPTIONS FOR MORE POWER...



**T**hanks to its engineers, that are experts in their subjects, Teksan offers you much more than a generator set by Putting your needs in the first place.



WHAT DOES TEKSAN SYNCHRONIZATION PROJECT PROVIDE YOU?



**S**ynchronization is to mount the same common busbar after the comparison of two or more generators groups' voltage frequency value's phase alignments and angles. Synchronous groups meet current load by sharing in ratio of their forces and work or stop automatically according to load alteration.

Thus, synchronous groups provide economic advantages and security. With purchasing single group generator set by identifying initial need, establishment's initial investment cost can be decreased and important savings in fuel consumption can be provided. Synchronized generator set provides remote control possibility to all functions by communicating with components as PLC computer, network, modem. Thanks to synchronized generator set transmits information to automatisaion systems, economy and security reach to high level.



## DIESEL GENSETS



Perkins



DOOSAN

YAVUZ MOTOR

MITSUBISHI  
DIESEL ENGINEMOTORS  
Baudouin

## Standard Equipments for Generator Sets

## Engine

In Teksan generator sets, leading engine brands that have state of the art technology and have compliance with ISO 8528, ISO 3046, BS 5514, DIN 6271 standarts, are being used. These engines with low fuel consumption, provide accurate speed setting and order, mount to the fuel pump, also have mechanic or electronic type governors.

## Alternator

In Teksan generator sets, leading alternator brands of the world that have state of the art technology, high quality, productivity and durability, are being used. All alternators, which pass necessary test process and found appropriate according to EC 60034-1; CEI EN 60034-1; BS 4999-5000; VDE 0530, NF 51- 100,111; OVE M-10, NEMA MG 1.22. standarts, have bearing system that does not need maintenance, with electronic type voltage regulator providing voltage setting.

## Control Panel

Standard control panel, that is used in Teksan generator sets, ensures comfortable and safe usage. All measured and statistical parameters, operating modes, notice and alarms and condition of generator, are monitored easily from the control panel. On the front of the panel's metal body has electronic control module and the emergency stop button and the panel's metal body is made of steel sheet and is painted with electrostatic powder paint. Teksan offers panel design and solutions that comply with special requirements of customers as well as quality standard panels.

## Chassis and Fuel Tank

Chassis is manufactured from steel that has features and durability for carrying burden of generator set. Thanks to its rigid structural design and anti-vibration mounts, it reduces vibration level to minimum. All chassis contain lifting lugs. Apart from chassis that are produce by Teksan, special solutions that design in accordance with customer desires, make transportation and positioning easier. In less than 1600 kVA power generator sets, fuel tank is produced integratedly to the chassis. In more than 1600 kVA power generator sets, rectangular type fuel tank is provided with generator set separately. In all types of fuel tank have its level and indicator.

## Cooling System

System, that consists of quality industrial-type radiator, expansion tank and cooler fan, keeps the temprature of generator set's equipments constant at a proper level.



WE PREFER  
HIGH QUALITY  
PRODUCTS OF THE WORLD'S  
MOST RESPECTFUL  
ALTERNATOR  
MANUFACTURERS.

## Some Optional Equipments for Generator Sets

- Medium voltage alternator,
- Remote radiator applications,
- Automatic fuel filling system,
- Fuel tank, oil pan, dashboard, alternator, coil heaters,
- Alternator with double AVR and PMG,
- Synchronization systems,
- The generator output breaker,
- Grid-generator transfer switches,
- Accordance with the specific volume of demand-insulated cabins,
- Seismic solutions,
- Trailer,
- Remote monitoring.



## COGENERATION POWER PACKS

### STRONG SOLUTIONS FOR FUTURE

**TEKSAN, thanks to its solid experience and know-how, delivers high performing natural gas and biogas-based cogeneration-trigeneration solutions with energy efficiency up to 90%. You can get your investment back in a short period of 4-5 years.**

**C**ogeneration is to obtain energy more than one form from fuel. In Cogeneration, the basic principle is to benefit accumulated heat in the system to provide saving by considering the electricity needs of the facilities. In cogeneration systems, at the result of energy local production energy productivity is increased by providing electricity and temperature needs. And consequently, emission levels are gotten under control and carbon footprint is decreased.

Moreover, decreasing energy costs increase the profitability of the plant and nowadays, an advantage in competitive conditions that become more difficult is provided. According to electrical and thermal load trends, in applications the co-operation of multiple sets can be provided and cogeneration systems work under maximum load, energy production in the highest efficiency and lowest cost can be established.



#### Advantages of Teksan Cogeneration Systems:

- Durable to work for many years, design that make it's dynamic and static analysis and calculations
- High efficiency due to it's equipment designed specially for cogeneration system
- Convenience in layout and maintenance course due to it's compact design,
- Investment return in short time thanks to feasibility calculations accurate analysis and suitable system design,
- Ease of augmentation of system capacity upon demand and simultaneous operation with diesel generators
- Low maintenance costs,
- In Teksan cogeneration systems, heat can be offered to the client in various ways. Along with standard hot air outlet, project based superheated steam and hot oil, cold water can be distributed too, in such projects which need cooling, via absorption chillers. Along with these, in greenhouses and projects that are demanding CO<sub>2</sub> usage, exhaust emissions are also utilisable.



Turbo Charger

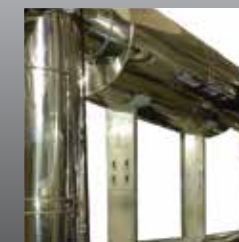

Manifold Heat Insulation



Temperature and Pressure Gauges



Jacket Heat Exchanger



Jacket Water Pump

## TRIGENERATION POWER PACKS

**T**rigeneration is the process of procuring cooling in addition to the electrical and heat outlets of cogeneration systems. In trigeneration systems, hot water or exhaust, exhaust, that are gathered from the engine, are being used to obtain cold water via absorption chillers. The trigeneration system is recommended in such implementations when the heat demand is used seasonally or in such implementations where cooling demand is higher than that of heating demand.

Sole or double effect absorption can be recommended depending on the cooling demand. In system absorption chillers provide cycle efficiency between 0,7 - 1,4 COP, depending on it's working principles. In Teksan Trigeneration Systems, in addition to the cogeneration packs; absorption chiller, cooling tower and cooling pumps are also presented to the client.





# HYBRID POWER SYSTEMS



Teksan Hybrid system is a complete electrical power supply solution that can be easily configured to meet a broad range of power needs.



- Telco Projects
- Agricultural Projects
- Construction Projects
- Events
- Remote Power
- Disaster Relief

-65%

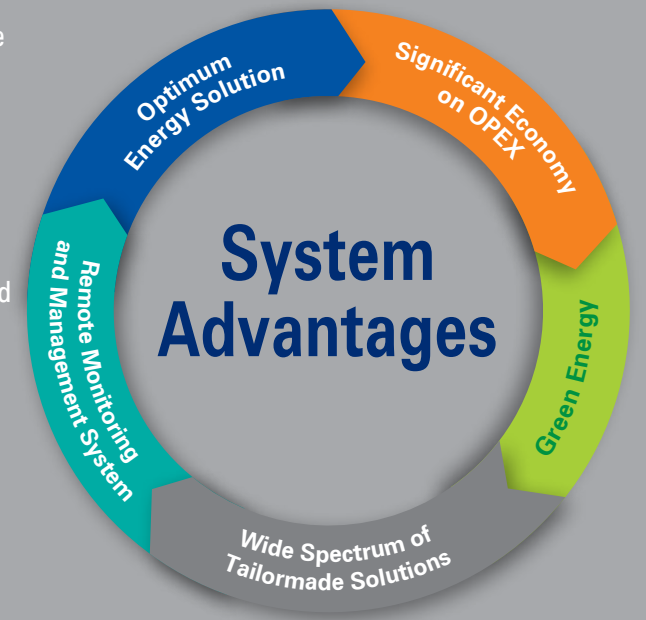

### Optimum Energy Solution

- Special system design gives the flexibility of adding renewable power sources to the system at any time.
- All-in-one design with possible lowest footprint saves significant space
- High tech battery system that is specially engineered for Hybrid power generators ensure the longest and most cost efficient service life.
- Highest charge efficiency and shorter charge time are achieved with unique charging method and latest battery technology

### Green Energy

- Lower fuel consumption by 65%,
- Reduces CO<sub>2</sub> emission,
- Reduces noise,
- Lower heat emissions.

### Wide Spectrum of Tailormade Solutions

- Thanks to our engineering know-how, tailormade Project experience, high quality components with contemporary technologies, we deliver high efficiency and sound solutions that matches with the specific needs of your projects.

### Significant Advantage in OPEX

- Lower generator set operating time up to 80%,
- Longer service intervals and fewer technical personnel allocation,
- Lower fuel consumption up to 65%,
- Reduces pay back period of the investment down to 1,5 years,
- Increases utilization period of the system.

### Remote Monitoring and Management System

- It is very handy and cost effective to monitor the performance of operation and to interfere the system in case of need from far distances with Remote Monitoring and Management System supported with GSM and internet technologies,
- You do not have to wait until your technical teams' attainment to the site,
- The risk of losing money due to interrupted services minimized because of the lower lag time in physical technical intervention.

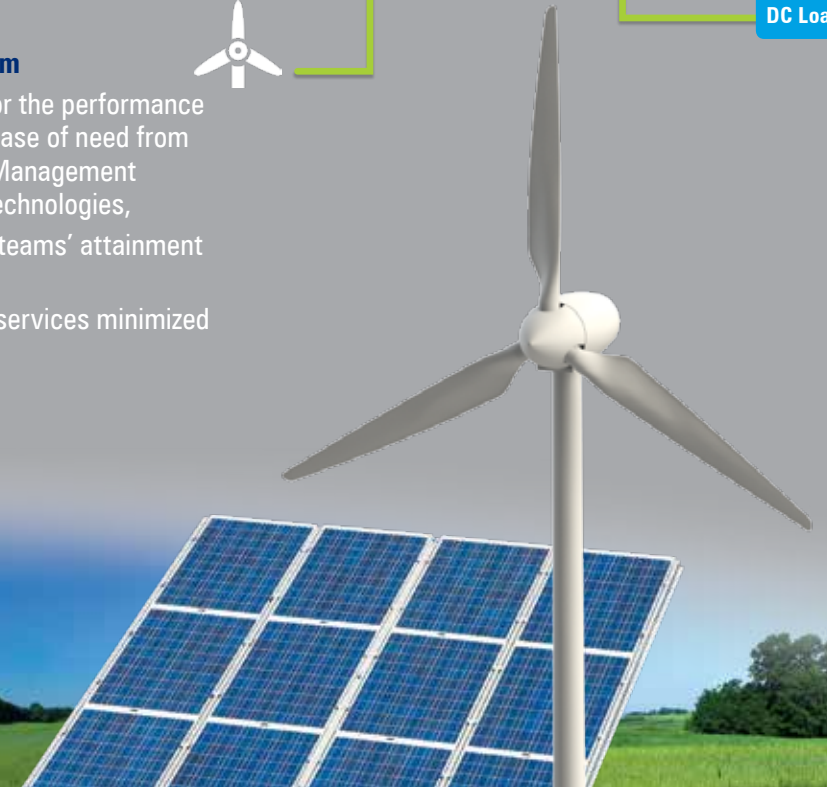
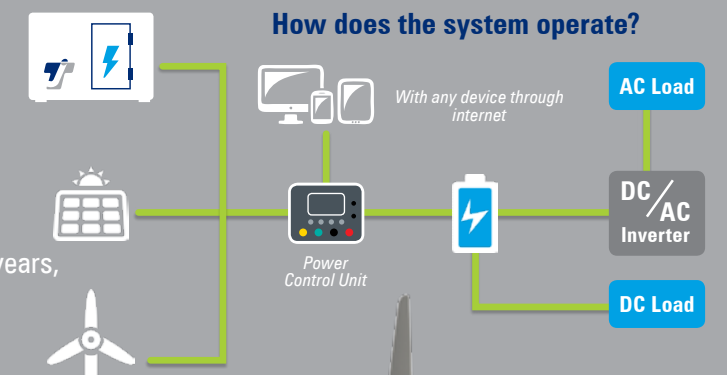



## PORTABLE GENERATOR SETS



### DO NOT UNDERESTIMATE IT!

Teksan Mini portable generator sets, thanks to high-tech engines they have, take little room but provide high performance.



Teksan Mini generator sets provide the power you need with maximum efficiency. Thanks to their compact and durable designs, high performance with low fuel consumption and different power output options, Teksan Mini products deliver more than you expect.



*\*Diesel and gasoline models are available*



Uninterrupted Power



Practical and Secure



High Performing



Automatic Circuit Breaker



Oil Level Maintainer



Durable



Economical

## CONTINUOUS SUPPORT

**T**eksan provides technical support services to its customers through a widespread distribution network.

- Free place and power detection,
- Assembly-disassembly,
- Periodic maintenance,
- Alteration,
- Technical support and advice,
- General maintenance,
- Emergency calls,
- Revision,
- Commissioning,
- Reparation.



### POWER AND PLACE DETECTION

One of the strongest sides of our Technical Service Team is to provide pre-exploration studies for determining energy needs, project designs, purchasing and engineering services including appropriate location selection for the generator sets.

### PERIODIC MAINTENANCE

With the commissioning of generator sets, in the frame of 'General Maintenance Schedule' determined by manufacturer making the checks and maintenance of generator sets, need to change consumables. It is proportional to the run time of the generator with the obligation to make periodic maintenance.

### WHY DO YOU NEED 'PERIODIC MAINTENANCE' CONTRACT?

- Generator sets work long lasting and efficiently,
- The financial and time losses sourced from the company or from the generator set are prevented,
- That provides advantage in planning of spare parts,
- Fast and prime services are offered,
- User-source errors are minimized.

## WE ARE AT YOUR SERVICE



### GUARANTEE

Teksan products are guaranteed for 30 months after the shipment and 2 years or 1000 hours of operation whichever comes first after the first start up against installation and manufacturing defects. Certificate Of Warranty is delivered with generator sets and guarantee process is initiated. Product informations and serial numbers are found in the generator identification label that is on the generator sets.

### SPARE PARTS

For providing better service of generator sets, original spare parts, that are recommended by 'Technical Services Team', should be used. Teksan is providing the best service for meeting needs with sufficient stock level for spare parts.

### TRAINING

Teksan Service Center is offering technical training support to all companies within Teksan Academy. Teksan can organize and conduct the essential trainings upon the request of the partner company with "beginner" or "advanced" content in accordance with the profile of the participants.





# INFINITE POWER SUPPLY TO ENTERPRISES



## POWERFUL TEAM THAT CARRIES OUT SUCCESSFUL PROJECTS!

R&D and Project departments of Teksan are moving together for producing optimal solutions that meet your wishes and needs. They are taking unique results from projects that they developed special for you.



Teksan, which has accumulated extensive knowledge and experienced expert engineer staff, has succeeded in system integration projects with different specifications and has reached the preferred brand in the international arena in special projects.

### Our Project Development Process

- Making the technical analysis of the project specifications,
- Making field and customer visits before and after sales for offering best solution to customer,
- Designing generator sets appropriate with technical parameters as voltage, frequency, altitude, temperature,
- Choosing special equipment for special projects,
- Carrying out of production appropriate with predetermined specification standart and schedule,
- Giving the required education to sales teams, distributors and end users for projects.

### Special Practices

- Product designs at size, power and noise levels that can depend on customer demands,
- Special fuel tank productions,
- Remote radiator practices,
- Special mobile generator sets,
- Seismic solutions,
- Special paint applications.

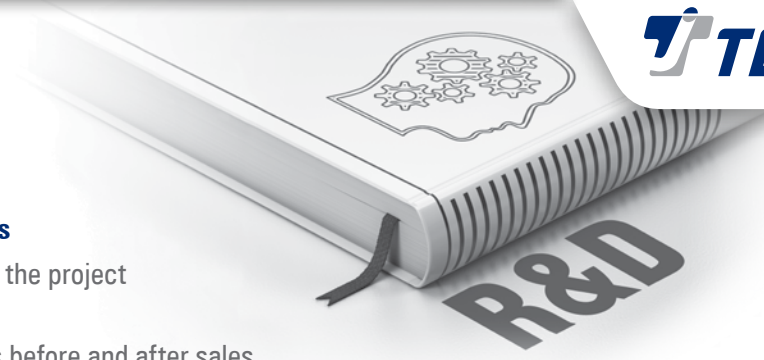
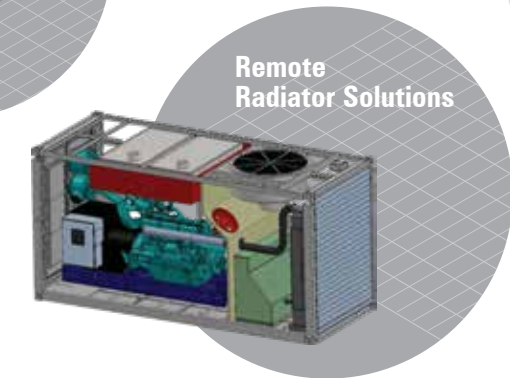
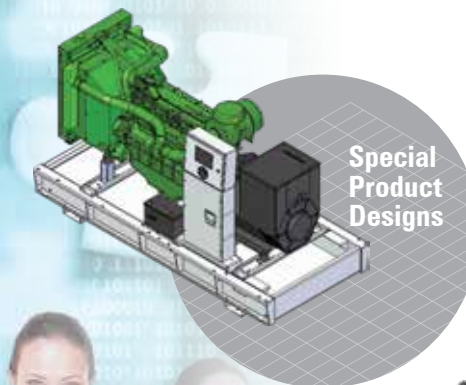



## POWERFUL SOLUTIONS FOR DIFFERENT SECTORS



**Sapphire Residence & Shopping Mall / Istanbul**



**Trabzon Akyazi Stadium / Trabzon**

**Kirikhan State Hospital / Hatay**



**Vialand Entertainment Center / Istanbul**



**T.P.A.O. Silivri / Istanbul**



**Sinpas Altin Oran Complex / Ankara**

2 x 2100 kVA  
Auto Diesel Generator Set  
2 x 1425 kVA  
Synchronized Diesel Generator Sets

1 x 1900 kVA Auto Diesel Generator Set  
1 x 2065 kVA Auto Diesel Generator Set  
1 x 2200 kVA Auto Diesel Generator Set

6 x 721 kVA  
Synchronized Diesel Generator Sets

17 x 1130 kVA  
Synchronized Diesel Generator Sets

1000 kW  
Natural Gas Generator Set

12 x 500 kVA  
Synchronized Diesel Generator Sets  
4 x 657 kVA  
Synchronized Diesel Generator Sets

**Symbol Kocaeli Shopping Mall Residence-Hospital / Izmit**  
2 x 1900 kVA Synchronized Diesel Generator Sets  
2 x 1400 kVA Synchronized Diesel Generator Sets  
2 x 676 kVA Synchronized Diesel Generator Sets  
1 x 821 kVA Auto Diesel Generator Set  
2 x 821 kVA Synchronized Diesel Generator Sets  
3 x 676 kVA Auto Diesel Generator Set

**Kepez State Hospital/ Antalya**  
4 x 1650 kVA  
Synchronized Diesel Generator Sets  
2 x 400 kW Trigeneration System

**Hatay State Hospital / Hatay**  
5 x 1900 kVA  
Synchronized Diesel Generator Sets

**Sutas Dairy Products Manufacturing Plant / Bursa**  
9 x 45 - 1130 kVA  
Synchronized Diesel Generator Sets

**Viaport Venezia / Istanbul**  
7 x 750 kVA Auto Diesel Generator Sets  
10 x 560 kVA Synchronized Diesel Generator Sets  
8 x 750 kVA Synchronized Diesel Generator Sets

**Istanbul Aquarium / Istanbul**  
1 x 1500 kVA Diesel Generator Set  
1 x 1900 kVA Diesel Generator Set

**Dogus Oto Kartal / Istanbul**  
4 x 552 kVA  
Synchronized Diesel Generator Sets

**Kar Maslak Offices / Istanbul**  
2 x 1600 kVA  
Synchronized Diesel Generator Sets

**Pendik Varyap Plaza / Istanbul**  
3 x 1100 kVA  
Synchronized Diesel Generator Sets

**Varyap Meridian Residence / Istanbul**  
8 x 660 kVA Synchronized Diesel Generator Sets  
8 x 750 kVA Synchronized Diesel Generator Sets  
2 x 880 kVA Synchronized Diesel Generator Sets  
1 x 825 kVA Synchronized Diesel Generator Sets

**Tasyapi Fourwinds Residence / Istanbul**  
6 x 1000 kVA  
Synchronized Diesel Generator Sets

**Anadolu Glass / Mersin**  
2 x 2280 kVA  
Auto Diesel Generator Set

**T.I.G.E.M. / Eskisehir**  
255 kW  
Biogas Cogeneration System

**ACITY Shopping Mall / Ankara**  
4 x 500 kW  
Synchronized Natural Gas Trigeneration Sets

**Sinan Erdem Sports Center / Istanbul**  
3 x 1900 kVA  
Synchronized Diesel Generator Sets

**Maiden's Tower / Istanbul**  
1 x 150 kVA Diesel Generator Set

**Carrefoursa Maltepe Park Shopping Mall / Istanbul**  
2 x 1130 kVA Synchronized Diesel Generator Sets  
2 x 905 kVA Synchronized Diesel Generator Sets

**Santa Farma Production Plant / Istanbul**  
3 x 2500 kVA  
Synchronized Diesel Generator Sets

**Anadolu Glass / Eskisehir**  
1 x 2065 kVA  
Synchronized Diesel Generator Sets

**Ankara Arena Sports Center / Ankara**  
2 x 1650 kVA  
Synchronized Diesel Generator Sets

**Bostanci Dedeman Hotel / Istanbul**  
4 x 1130 kVA  
Synchronized Diesel Generator Sets

**Hilton Kozyatagi / Istanbul**  
4 x 774 kVA  
Synchronized Diesel Generator Sets

**Igdir Hospital/ Igdir**  
2 x 1000 kVA Synchronized Diesel Generator Sets  
3 x 819 kVA Synchronized Diesel Generator Sets

**Erzurum Airport/ Erzurum**  
2 x 1125 kVA  
Synchronized Diesel Generator Sets

**The Avenue Bodrum Shopping Mall / Bodrum**  
2 x 774 kVA  
Synchronized Diesel Generator Sets

**Brandium Shopping Mall / Istanbul**  
22 x 774 kVA, 4 x 660 kVA  
Synchronized Diesel Generator Sets

**Armada Shopping Mall / Ankara**  
4 x 740 kVA Synchronized Diesel Generator Sets

**Edirne State Hospital / Edirne**  
2 x 430 kW  
Trigeneration System

**Sivas State Hospital / Sivas**  
5 x 1650 kVA  
Synchronized Diesel Generator Sets

**Malatya State Hospital / Malatya**  
4 x 1900 kVA  
Synchronized Diesel Generator Sets

**Van Gynaecology Hospital / Van**  
2 x 880 kW  
Cogeneration System

**WOW Convention Center / Istanbul**  
2 x 560 kVA  
Synchronized Diesel Generator Sets

**Izmir Technopark / Izmir**  
1 x 1650 kVA Diesel Generator Set  
1 x 1130 kVA Diesel Generator Set  
1 x 825 kVA Diesel Generator Set

**The Bodrum Museum of Underwater Archaeology / Bodrum**  
1 x 405 kVA Diesel Generator Set

**Tarabya Presidential Campus (Huber Villa) / Istanbul**  
2 x 500 kVA  
Synchronized Diesel Generator Sets

**Topkapi Palace / Istanbul**  
1 x 424 kVA  
Diesel Generator Set



## IN MORE THAN 130 COUNTRIES...

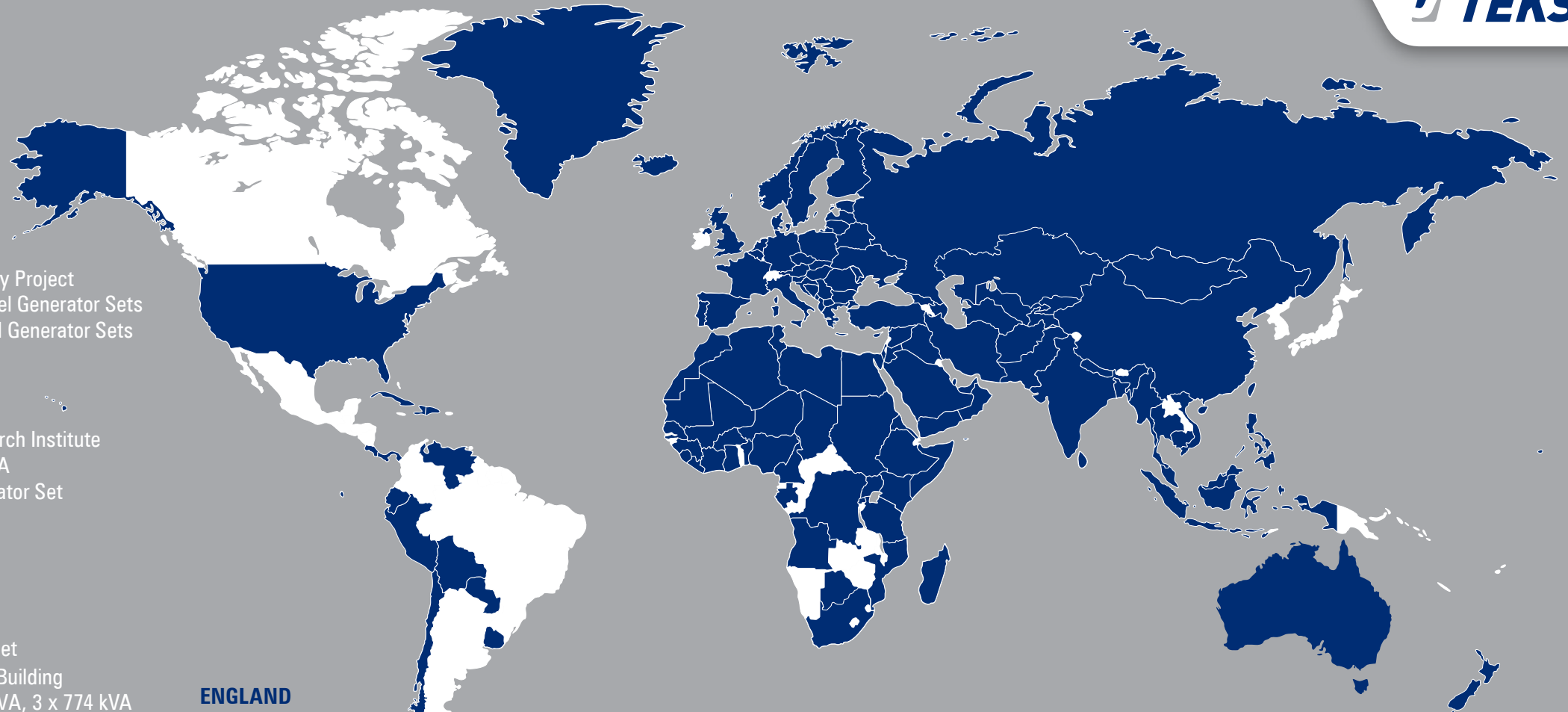

### TURKMENISTAN

- New Ashgabat International Airport  
36 Units of Standby and Synchronized Diesel GenSets  
Ranging from 145 kVA to 1900 kVA

### GERMANY

- EMBL Heidelberg Biological Research Institute  
Standby 1000 kVA Diesel Generator Set  
Synchronized with the Main Grid

### BELARUS

- Prostore Shopping Mall  
Standby 1010 kVA & 680 kVA Auto Diesel Generator Sets  
Container Type Canopy

### BOLIVIA

- Aguai Sugarworks Production Plant  
Standby 3 x 1400 kVA Synchronized Diesel Generator Sets

### BOTSWANA

- Botswana Telecom  
Standby 30 x 22-90 kVA Auto Diesel Generator Sets

### BULGARIA

- Thermal Power Plant  
Standby 2 x 1130 kVA Diesel Generator Sets  
20 ft Container Canopy (Silent)

### GEORGIA

- Pro Credit Bank  
Standby 2 x 774 kVA Synchronized Diesel Generator Sets

### GREECE

- Siemens Motorway Project  
2 x 1900 kVA Diesel Generator Sets  
2 x 660 kVA Diesel Generator Sets

### GREENLAND

- Zackenberg Research Institute  
Standby 1 x 27 kVA Auto Diesel Generator Set  
0°C Cold Start

### HOLLAND

- Vodafone Arnheim  
Standby 1010 kVA Diesel Generator Set
- Duo2 Consortium Building  
Standby 2 x 905 kVA, 3 x 774 kVA Synchronized Diesel Generator Sets
- Provincial Waterworks Andjik  
Standby 4 x 2200 kVA Synchronized Diesel Generator Sets

### NETHERLAND ANTILLES

- Lions Dive & Beach Resort Curacao  
Standby 560 kVA Diesel Generator Sets

### IRAQ

- Basra Oil Reservoir  
Prime 9 x 2500 kVA Synchronized Diesel Generator Sets
- Sulaymaniyah Hospital  
Standby 3 x 1650 kVA Synchronized Diesel Generator Sets
- Najaf Al-Furat & Almanathire Hospitals  
Standby 4 x 2280 kVA, 2 x 1400 kVA Synchronized Diesel Generator Sets
- Erbil Italian Village  
Standby 3 x 1135 kVA Synchronized Diesel Generator Sets

### ENGLAND

- Southmead Hospital  
Standby 2 x 1035 kVA Integrated with Building Management Systems  
Silent Canopy

### KAZAKHSTAN

- Dostyk Plaza  
Standby 2 x 2025 kVA Auto Diesel Generator Sets  
Container Type Canopy

### QATAR

- Samko Engineering Doha  
Standby 3 x 1000 kVA Diesel Generator Sets

### KENYA

- Safari Hotel  
Standby 2 x 400 kVA Diesel Generator Sets  
Cogeneration:  
Prime 4 x 275 kVA Diesel Generator Sets

### LIBYA

- Artificial River Projects  
Standby 2 x 275 kVA Diesel Generator Sets

### EGYPT

- Savola Desert Irrigation Project  
Standby 77 x 330 kVA  
No exhalation even in the hottest climate special filtration against sand storms  
Diesel Generator Sets

### NEPAL

- Fort Resort Hotel  
1 x 180 kVA  
Altitude of 2.200 meters  
Diesel Generator Set

### ROMANIA

- Tower Business Center  
Standby 400 kVA and 1125 kVA Remote Radiator  
Diesel Generator Set

### RUSSIA

- AURA Shopping Mall-Plaza  
1500 kVA Diesel Generator Set

### RWANDA

- Serena Hotel  
3 x 700 kVA Synchronized Diesel Generator Sets

### SUDAN

- Ferronile Steel Factory  
Standby 3 x 2120 kVA, 2 x 1915 kVA Synchronized Diesel Generator Sets

### SAUDI ARABIA

- Rejal Alma Sewage Treatment Plant  
Standby 1400 kVA ISO Type / Canopied Diesel Generator Sets
- Mövenpick Hotel Jeddah  
Standby 1 x 1400 kVA Synchronized Diesel Generator Sets

### TANZANIA

- Vodafone  
Standby 2 x 1130 kVA Diesel Generator Sets  
30 ft Container Type Canopy

### THAILAND

- CCZ Hospital  
Standby 1900 kVA Auto Diesel Generator Sets

### UKRAINE

- Ukgazbank  
Standby 520 kVA Diesel Generator Sets

### NEW ZEALAND

- Standby 1010 kVA Diesel Generator Set parallel with the main grid  
30 ft Container



*Savola Desert Irrigation Project / Egypt*  
Standby 77 x 330 kVA  
No overheating even in the hottest climate  
Diesel Generator Sets



*Zackenberg Research Institute / Greenland*  
Standby 1 x 27 kVA  
0°C cold start  
Auto Diesel Generator Set



*Fort Resort Hotel / Nepal*  
1 x 180 kVA  
Operating at higher altitude (2200 + meters)  
Diesel Generator Set

**TEKSAN IS ALWAYS WITH YOU...**







*EVERLASTING  
COMPANY*



+90 **444 8576**  
[www.teksan.com](http://www.teksan.com)  
[info@teksan.com](mailto:info@teksan.com)