

MAKELSON[®]

Uninterruptible Power Supplies

USER MANUAL

Powerpack SE

RT Series

1 - 10 KVA

USER MANUAL

Powerpack SE

RT Series

1 - 10 KVA

UDD-SD-123

About The Manual

This manual is prepared for the users of Powerpack SE RT Series 1-3 kVA.

Companion Manuals

For further information about this device and its options, please visit www.makelsan.com.tr

Updates

Please visit www.makelsan.com.tr for updates. Always use the latest manuals.

Shipment

Carrying vehicles or handling accessories must have enough features and characteristics to carry UPS's weight.



DO NOT LIFT HEAVY DUTY WEIGHT WITHOUT HELP



<18 kg (<40 lb)



32–55 kg (70–120 lb)



18–32 kg (40–70 lb)



>55 kg (>120 lb)

Be more careful of sudden movements, especially when batteries are inside of cabinet.



Thanks for using our products.

Please strictly obey all the instructions in this manual and pay attention to all the warning and operation information. It is not advisable to install or operate the machine before reading this manual.

CONTENTS

- 1 SAFETY INSTRUCTIONS 7
- 2 INSTALLATION INSTRUCTIONS 8
 - 2.1 Unpacking Inspection 8
 - 2.2 Attention Items of Installation 9
 - 2.3 UPS and Battery Pack Rear Panel View 9
 - 2.3.1 The Type of 120V (Output could be 100V, 110V, 115V, 127V)..... 10
 - 2.3.2 The Type of 220V (Output could be 208V, 210V, 220V, 230V, 240V)..... 11
 - 2.4 UPS Output Connection 12
 - 2.5 External Battery Connection Procedure For Long Back Up Type..... 12
 - 2.6 Installation..... 13
- 3 PANEL FUNCTION and OPERATION 15
 - 3.1 Keys Function 15
 - 3.2 LED Function..... 17
 - 3.3 LED Display Function 17
 - 3.4 Turn On/Off Operation 19
 - 3.4.1 Turn On Operation..... 19
 - 3.4.2 Turn Off Operation..... 19
 - 3.5 UPS Self-Test / Mute Operation 20
 - 3.6 Panel Function Setting 20
 - 3.6.1 ECO Mode Setting 20
 - 3.6.2 Bypass Mode Setting 21
 - 3.6.3 Output Mode Setting 22
 - 3.6.4 Low Voltage of Battery Setting..... 23
 - 3.7 Parameters Inquiring Operation..... 24
- 4 WORKING MODE INTRODUCTION 26
 - 4.1 Bypass Mode 26
 - 4.2 Line Mode 26
 - 4.3 Battery Mode..... 26
 - 4.4 ECO Mode 27
 - 4.5 Fault Mode..... 27
- 5 THE WARNING LIST OF THE LOGHT and DISPLAY PANEL 28
- 6 TROUBLE SHOOTING..... 31
- 7 ATTENTION BOF BATTERY DISPOSAL 33

8 NETWORK COMMUNICATION 33

9 COMMUNICATION INTERFACE INTRODUCTION 33

10 GUARANTEE 39

 10.1 Terms of Guarantee 39

 10.2 Cases Not Covered by the Guarantee 40

11 CONTACT INFORMATION 42

1 SAFETY INSTRUCTIONS

- The power output voltage may still have 220V or 120V even not connect to the mains power.
- For the battery cable or power cord replacement, please contact our service station or dealer to purchase, in order to avoid fire caused by inadequate capacity or heat ignition.
- Do not place the battery or battery pack in the fire, which will injure due to explosion.
- Please do not open the UPS case as you will, there is risk of electric shock
- Do not touch the battery connection terminals. Battery loop and input voltage loop is without isolation, which may cause high voltage risk between the battery terminal and ground.
- Do not connect to the equipment like hair dryer or electric heater, to ensure the safety for the UPS

2 INSTALLATION INSTRUCTIONS



2.1 Unpacking Inspection

- Open the UPS package, please check the enclosed accessories including a user manual, communication cable, support feet, CD-ROM. The long-back model also includes the cable for connection to battery bank.
- Check the UPS if any damage in transport. If find it's damaged or parts missing, do not power on, please turn to the carrier and dealer.
- To determine whether this UPS is the model you want to buy. Check the model name showed both on the front panel and rear panel of UPS to confirm.

Model	Type	Model	Type
1KVARTS	1KVA RT Standard model	1KVARTH	1KVA RT Long backup model
2KVARTS	2KVA RT Standard model	2KVARTH	2KVA RT Long backup model
3KVARTS	3KVA RT Standard model	3KVARTH	3KVA RT Long backup model
6KVARTS	6KVA RT Standard model	6KVARTH	6KVA RT Long backup model
10KVARTS	10KVA RT Standard model	10KVARTH	10KVA RT Long backup model

NOTE:

Please save the packaging box and packaging materials for future transport use. As heavy product, please transit the UPS with care.

2.2 Attention Items of Installation

- The UPS installation environment must be with good ventilation, away from water, flammable gases and corrosive entities.
- Do not lie down the UPS against the wall so that front and side panel air intake hole, rear panel air outtake hole will be unobstructed.
- The peripheral environment temperature around the UPS should be within 0 °C ~ 40 °C.
- If dismantling the machine at low temperatures, there may be condensation droplets, users can not install or operate it before UPS completely got dry both inside and outside, otherwise there will be danger of electric shock.
- Place the UPS near the mains socket to cut off AC mains without any delay at any emergent case.

ATTENTION:

- Make sure the load behind the UPS is off when users connect the load to UPS, and then turn on the load one by one later.
- Please connect the UPS with the socket which is over-current protected. Do not connect the UPS with the socket which rated current is less than the Maximum input current of the UPS.
- All the power socket should be configured with earthing device for safety.
- UPS could be electrified or powered no matter the input power cable is tied or not, even when the UPS is off. The only way to cut off the output is switching off the UPS, disable the EPO and disconnecting the mains power supply.
- For all standard type UPS, it is advised to charge the battery over 8 hours before used. Once the AC mains power energizes the UPS, it will automatically charge the battery. Without prior charging, UPS output remains as usual but with shorter back-up time than normal.
- When connected to motor, display equipment, laser printer etc, UPS power selection should be based on the startup power of the load which is usually twice as rated power.

2.3 UPS and Battery Pack Rear Panel View

NOTE:

Following diagrams take the type of 0.9PF for example, the type of 0.8PF is similar.

2.3.1 The Type of 120V (Output could be 100V, 110V, 115V, 127V)

A. Standard Model

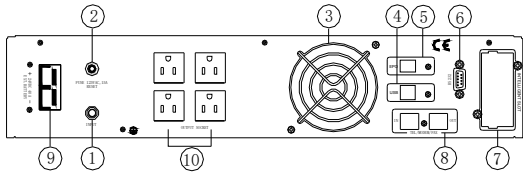

a. 0.9PF 1KVA RT rear panel

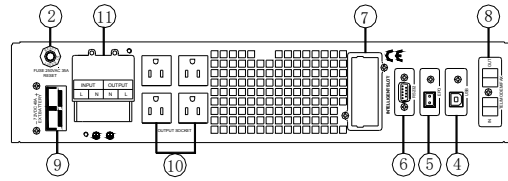

b. 0.9PF 2KVA&3KVA RT rear panel

B. Long-Run Model

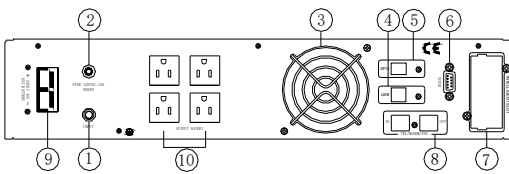

a. 0.9PF 1KVA RT rear panel

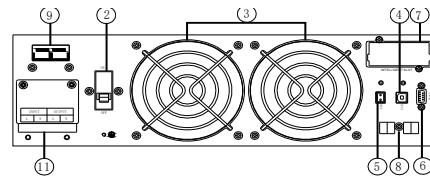

b. 0.9PF 2KVA RT rear panel

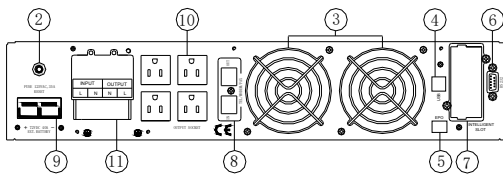

c. 0.9PF 3KVA RT rear panel

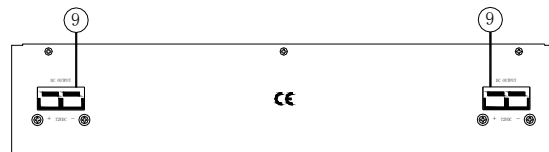

d. 0.9PF Battery Pack rear panel

2.3.2 The Type of 220V (Output could be 208V, 210V, 220V, 230V, 240V)

A. Standard Model

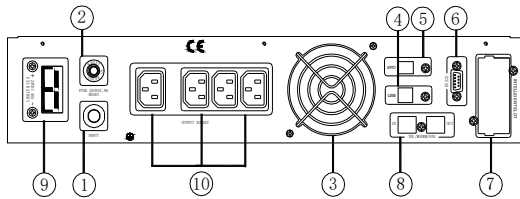

a. 0.9PF 1KVA RT rear panel

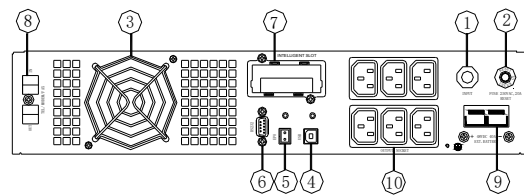

b. 0.9PF 2KVA RT rear panel

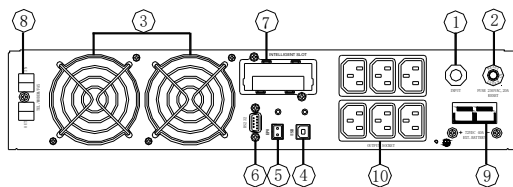

c. 0.9PF 3KVA RT rear panel

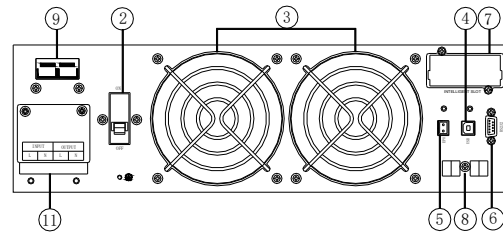

d. 0.9PF 6/10KVA RT rear panel

B. Long-Run Model

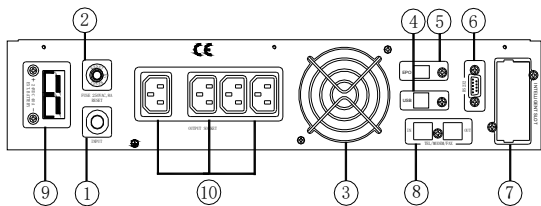

a. 0.9PF 1KVA RT rear panel

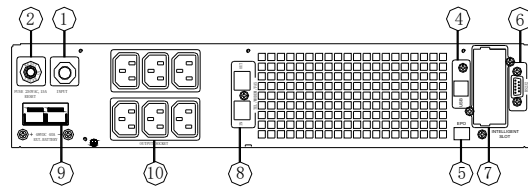

b. 0.9PF 2KVA RT rear panel

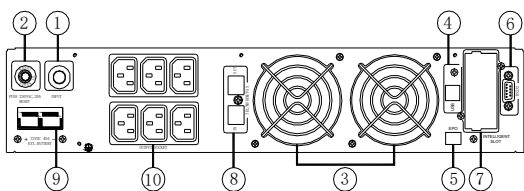

c. 0.9PF 3KVA RT rear panel

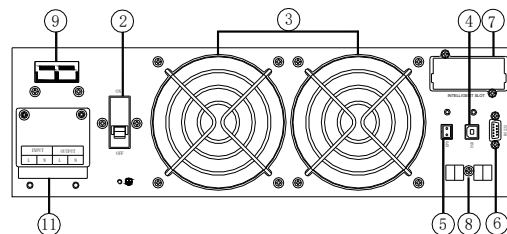

d. 0.9PF 6/10KVA RT rear panel

<ul style="list-style-type: none"> 1. Input Power Terminals 2. Over Current Protector 3. Fan 4. USB 5. Emergency Power Off 6. RS232 Communication Interface 	<ul style="list-style-type: none"> 7. Intelligent Slot 8. Surge Protection for Network/Fax/Modem 9. Battery Slot 10. Output Socket 11. Terminal Block
---	--

NOTE:

Diagrams take the type of 0.9PF for example, the type of 0.8PF is similar. Due to the technology upgrading and development, goods and diagrams might have some differences.

2.4 UPS Output Connection

Output connection of 1~10KVA type is configured with sockets or terminal blocks, users can plug the load cable into the UPS socket to energize the load as below. Make sure the mains wire and breakers in the building are enough for the rated capacity of UPS to avoid the hazards of electric shock or fire.

NOTE:

To the type of 6-10KVA, do not use the wall receptacle as the input power source for the UPS, which rated current is less than the UPS's maximum input current. Otherwise the receptacle may be burned and destroyed.

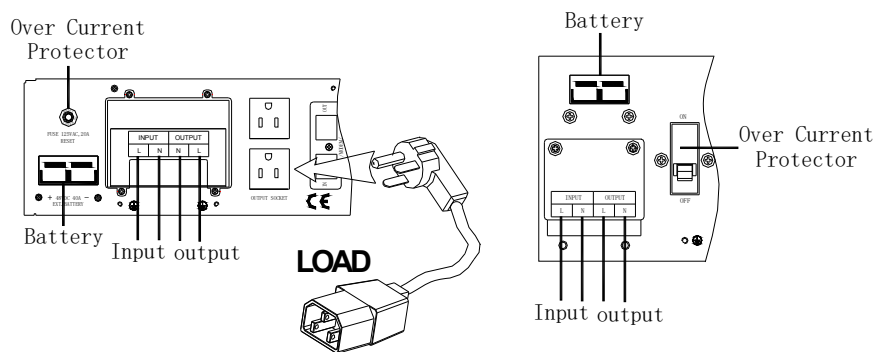

2.5 External Battery Connection Procedure For Long Back Up Type

- For different UPS type, users are instructed to configure different battery voltage as below sheet. More or less units are forbidden, or else something abnormal or faulty will appear.

Type	Battery Quantity (unit)	Battery Voltage (volt)
1KVA	2/3	24/36
2KVA	4/6	48/72
3KVA	6/8	72/96
6KVA	16	192
10KVA	16	192

- One end of battery cable is for UPS terminals while the other end with triple cables is for battery terminals. Correct installation procedure is highly vital or else probable electric shock will arise. Users are strictly required to follow the below procedure.

- Connect battery in correct way and make sure the total battery voltage is available for UPS.
- Correctly connect the long battery cable to battery terminals first, red wire is to positive plate while black is to negative. If users connect the UPS first, electric shock or other danger could not be avoided.
- Before connecting load after UPS, users should supply main power to UPS and energize it.
- Connect long battery cable to UPS terminals with correct poles link (red is for "+", black is for "-"), UPS will start the charging work automatically.

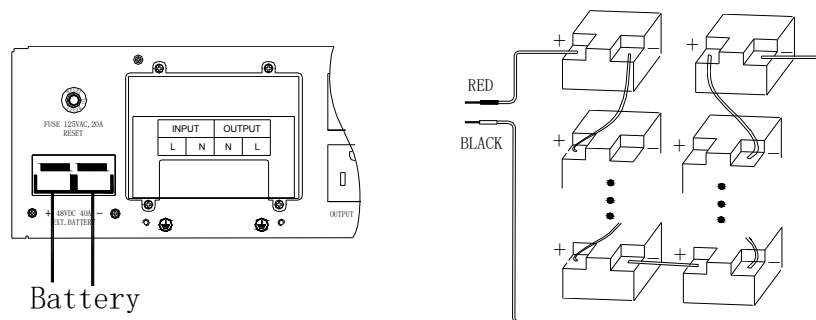

2.6 Installation

- UPS installation work should comply with local electrical standard and only can be done by professional technician. 1KVA~3KVA units could use wall socket as input power connection.
- For all type UPS, it is advised to charge the battery over 8 hours before the first use. Once the AC mains power energizes the UPS, it will charge the battery automatically. Without prior charging, UPS output remains as usual but with shorter back up time than normal.

Installation steps :

1. Please take out two groups of support feet from package, assemble by embedding them with each other as shown below.



2. Place the two support feet in parallel on horizontal surface, and then put the machine into two support feet carefully. Make sure the main power is off when you move it.



3. It also can be placed horizontally without support feet if you like, please remember not to put the machine upside down. Please lie it down carefully and make sure the main power is off.



4. Machine and battery pack, can be put together, as two ways are showed in the pictures below, the battery pack should be put under the machine. The battery pack is heavy, be careful when you move it.



3 PANEL FUNCTION and OPERATION

The operation is simple, operators only need to read the manual and follow the operation instructions listed in this manual without any special training.

3.1 Keys Function

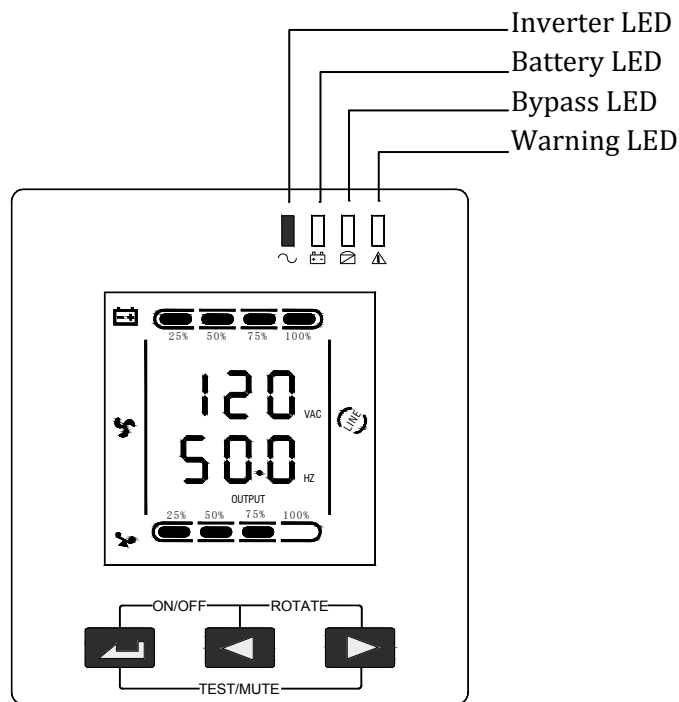

※ **ON/OFF key** (◀ + ▶)

Press and hold this key for more than half a second to turn on/off the UPS.

※ **TEST/MUTE key** (◀ + ▶)

Press and hold the key for more than 1 second in mains mode or economical mode: UPS runs the self-test function.

Press and hold the key for more than 1 second in battery mode: UPS runs the mute function.

※ **ROTATE key** (◀ + ▶)

Press and hold ◀ and ▶ for more than half a second (less than 2 seconds): Change the direction to display items.

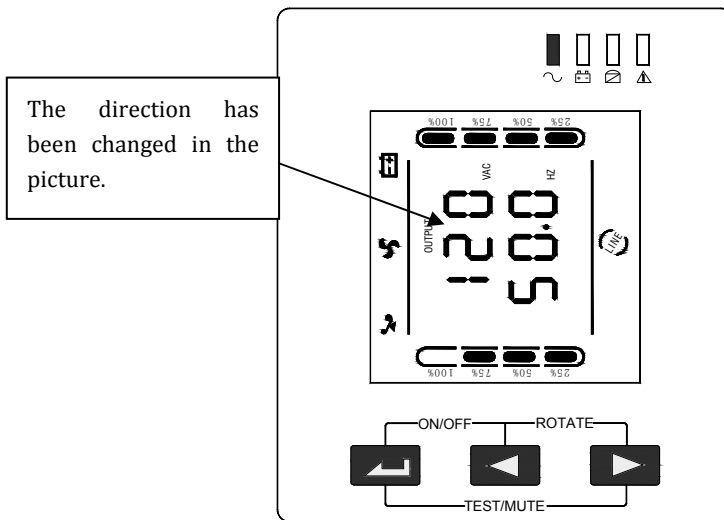
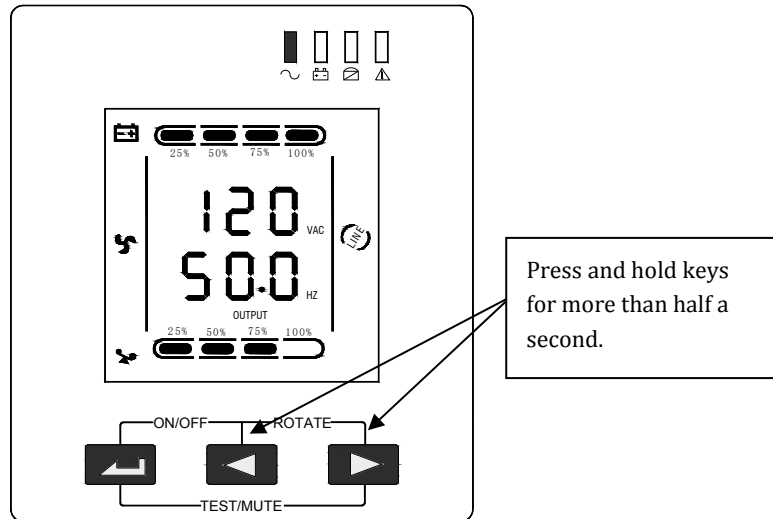

After finishing that, the machine can be placed flat, as shown in the picture below.

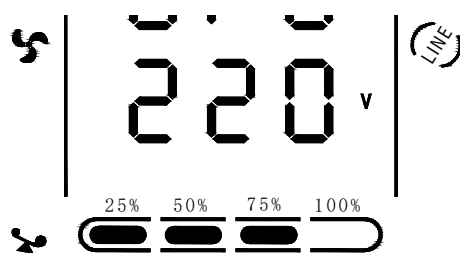

※ **INQUIRING key** (◀ , ▶)

Non-function setting mode:

- 1) Press and hold ◀ or ▶ for more than half a second (less than 2 seconds): display the items orderly.
- 2) Press and hold ▶ for more than 2 seconds: Circularly and orderly display the items every 2 seconds, when press and hold the key for some time again, it will turn to output status.

Function setting mode:

Press and hold the key for more than half a second (less than 2 seconds): Select the set option.

※ **FUNCTION SETTING** key 

Non-function setting mode:

Press and hold the key for more than 2 seconds: Function setting interface.

Function setting mode:

Press and hold the key for more than half a second (less than 2 seconds): Enter the function setting option

Press and hold the key for more than 2 seconds, exit from this function setting interface.

3.2 LED Function



From left to right is inverter LED, battery LED, bypass LED and warning LED.

Warning red LED is on: UPS fault. For example: Overload beyond the allowed time, inverter fault, BUS fault, over temperature fault etc.

Bypass yellow LED is on: UPS is alarming. For example: Bypass mode supply power and etc.

Battery yellow LED is on: UPS is alarming. For example: Battery mode supply power and etc.

Inverter green LED is on: UPS is normally powered by mains or ECO mode or battery mode.

PS: LED display detail in different mode is listed in 5 items.

3.3 LED Display Function

LCD displays as following figure.

※ **Icon display area:**

1. The top diagram is for load, battery, fan, fault and buzzer icon. When UPS is over loaded, the load light will blink as same as the battery light blinks when the capacity of battery gets low or battery is disconnected. The left icon and right icon are for load and battery capacity indication, each grid of which represents 25%.
2. The fan icon is for fan working indication; when fan normally runs, the icon will display rotation; if the fan is not connecting or faulty, the icon blinks;
3. Press the mute button under the battery mode, buzzer icon will blink; it will disappear under other cases.

4. Fault icon will be on when UPS on fault mode, otherwise it will not.

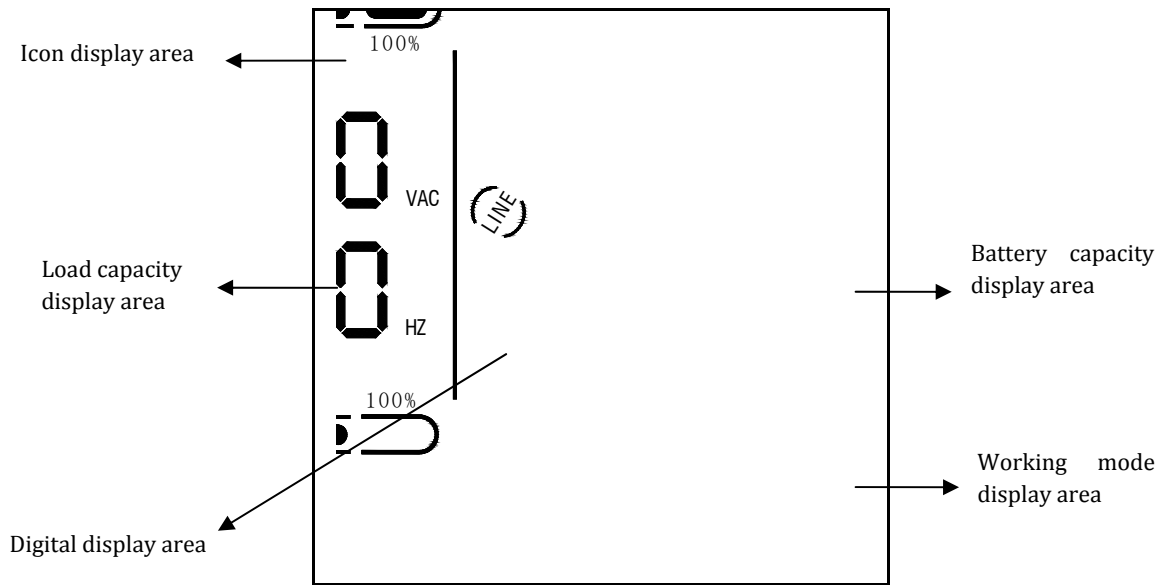

※ **Digital display area:**

- Under none setting mode, it will display UPS output information when UPS normally runs in AC mode; other information like input, battery, load and temperature will be showed after pressing the inquiring key; Fault code will be told in fault mode.
- Under setting mode, user could adjust different output voltage as well as activate ECO and BYPASS mode by operating function setting key and inquiring keys.

※ **Mode display area:**

After over 20 seconds, this area will display the working mode of the machine. e.g. STDBY(Standby Mode), BYPASS(Bypass Mode), LINE(AC mode), BAT(Battery mode), BATT(Battery Self Test Mode), ECO(Economic Mode), SHUTDN(Shutdown Mode).

3.4 Turn On/Off Operation

3.4.1 Turn On Operation

A. Turn on the UPS on Line mode

- Once mains power is plugged in, the UPS will charge the battery, at the moment, LCD shows that the output voltage is 0, which means UPS has no output as default condition. If it is expected to have output of bypass, you can set the bps “ON” by LCD setting menu.
- Press and hold the ON key for more than half a second to start the UPS, then it will start the inverter.
- Once started, the UPS will perform a self-test function, LED will light and go out circularly and orderly. When self-test finishes, it will come to line mode, the corresponding LED lights, UPS is working on line mode.

B. Turn on the UPS by DC without mains power

- When main power is disconnected, press and hold the ON key for more than half a second to start UPS.
- The operation of UPS in the process of start is almost the same as that when mains power is in. After finishing the self-test, the corresponding LED lights and UPS is working on battery mode.

3.4.2 Turn Off Operation

A. Turn off the UPS on line mode

- Press and hold the OFF key for more than half a second to turn off the UPS and inverter.
- After UPS shutting down, LED go out and there is no output. If output is needed, you can set bps “ON” on LCD setting menu.

B. Turn off the UPS by DC without mains power

- Press and hold the OFF key for more than half a second to turn off the UPS.
- When turning off the UPS, it will do self-testing firstly. LED light and go out circularly and orderly until there is no display on the panel.







3.5 UPS Self-Test / Mute Operation

- When UPS is on line mode, press and hold the self-test/mute key for more than 1 second, LED light and go out circularly and orderly. UPS comes to self-test mode and tests its status. It will exit automatically after finishing testing, LED resume.
- When UPS is on battery mode, press and hold the self-test/mute key for more than 1 second, the buzzer stops beeping. If you press and hold the self-test/mute key for one more second, it will restart to beep again.

3.6 Panel Function Setting





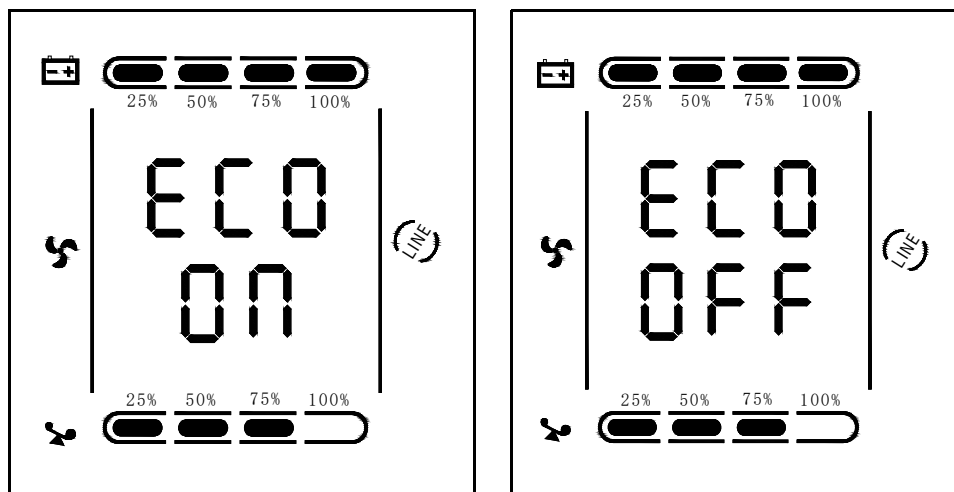

UPS has setting function. It can run the setting on any mode. After setting, it will become effective at once when meets some standards. The set information can be saved only when the battery connected and normally turning off the UPS.

3.6.1 ECO Mode Setting

- Enter the setting interface. Press and hold the function setting key  for more than 2 seconds, then come to setting interface, the letters "ECO" will flash.
- Enter the ECO setting interface. Press and hold the function setting key  for more than half a second (less than 2 seconds), then come to setting interface of ECO, at this time, the letters "ECO" will light for a long time. The "ON" (or OFF) will flash. Press and hold the inquiring key ( , ) for more than half a second (less than 2 seconds) to determine whether the ECO function is used or not. If used, the corresponding word is "ON", if not, the word is "OFF". It can be determined by yourself.
- Confirm the ECO selecting interface. After selecting ON or OFF, press and hold the function setting key  for more than half a second (less than 2 seconds). Now, the ECO setting function is completed and the "ON" or "OFF" will light without flash.
- Exit from the setting interface. Press and hold function setting key  for more than 2 seconds, exit from the setting interface and turn to main interface.







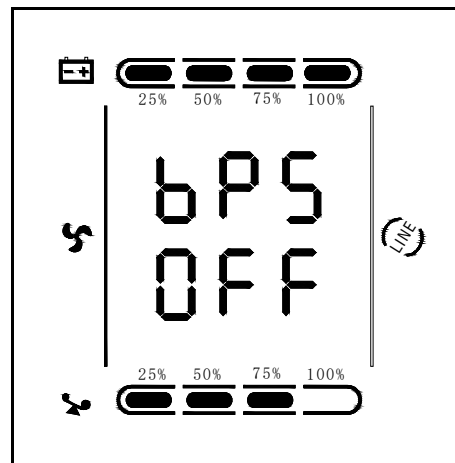
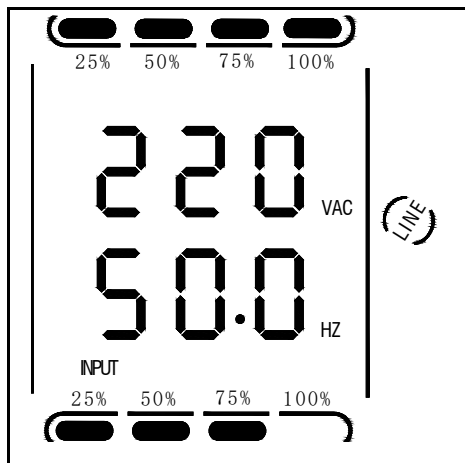



3.6.2 Bypass Mode Setting

- Enter the setting interface. Press and hold the function setting key  for more than 2 seconds, then come to setting interface, Press and hold the function setting key  for more than half a second (less than 2 seconds), select the function setting, choose the bypass output interface, at the moment, the letters “BPS” will flash.
- Enter the Bypass output selecting interface. Press and hold the function setting key  for more than half a second (less than 2 seconds), then come to setting interface of BPS, at this time, the letters “BPS” will light for a long time. The “ON” letter will flash. Press and hold the inquiring key ( , ) for more than half a second (less than 2 seconds) to determine whether the BPS function is used or not. If used, the corresponding word is “ON”, if not, the word is “OFF”. It can be determined by yourself.
- Confirm the Bypass output selecting interface. After selecting ON or OFF, press and hold the function setting key  for more than half a second (less than 2 seconds), Now, the BPS setting function is completed and the “ON” or “OFF” will light without flash.
- Press and hold function setting key  for more than 2 seconds, exit from the setting interface and return to main interface.
- After setting BPS as ON, when mains power plugged in without turning on the UPS or no mains power plugged in, there is bypass output but no power down backup function.







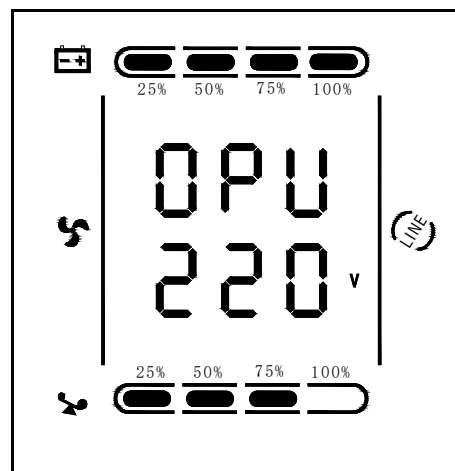
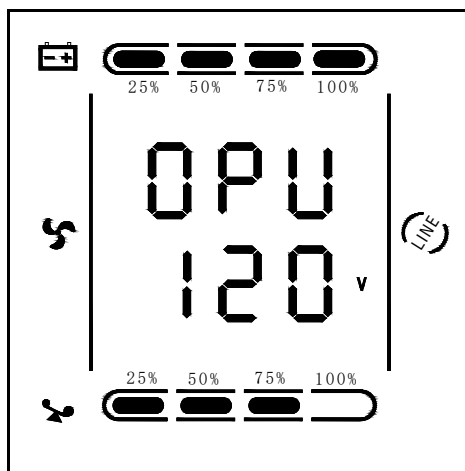



3.6.3 Output Mode Setting

- Enter the setting interface. Press and hold the function setting key  for more than 2 seconds, then come to setting interface, Press and hold the inquiring key ( , ) for more than half a second (less than 2 seconds), select the function setting, choose output voltage setting interface, at the moment, the letters “OPU” will flash.
- Enter the output voltage selecting interface. Press and hold the function setting key  for more than half a second (less than 2 seconds), then come to setting interface of output voltage OPU, at this time, the letters “OPU” will light for a long time. The numerical value below the OPU will flash. Press and hold the inquiring key ( , ) for more than half a second (less than 2 seconds), select the numerical value in accordance with “OPU” function. The provided voltages are 100, 110V, 115V, 120V, 127V or 208V, 210V, 220V, 230V, 240V, you can choose anyone by yourself.
- Confirm the output voltage selecting interface. After selecting numerical value, press and hold the function setting  , for more than half a second (less than 2 seconds). Now, the OPU setting function is completed and the numerical value will light without flash.
- Exit from the setting interface. Press and hold function setting key  for more than half a second (less than 2 seconds), exit from the setting interface and return to main interface.



3.6.4 Low Voltage of Battery Setting

- Enter the setting interface. Press and hold the function setting key  for more than 2 seconds, then come to setting interface, Press and hold the inquiring key ( , ) for more than half a second (less than 2 seconds), select the function setting, choose battery voltage setting interface, at the moment, the letters “bat” will flash.
- Enter the battery voltage selecting interface. Press and hold the function setting key  for more than half a second (less than 2 seconds), then come to setting interface of battery voltage, at this time, the letters “bat” will light for a long time. The numerical value below the “bat” will flash. Press and hold the inquiring key ( , ) for more than half a second (less than 2 seconds), select the numerical value in accordance with “battery” function. The provided voltages are 10V, 10.2V, 10.5V, numbers stand for the voltage of each battery, you can choose anyone by yourself (The default is 10V), anyone has been chosen, the machine will shutdown when its battery voltage achieve the voltage which you chose.
- Confirm the battery voltage selecting interface. After selecting numerical value, press and hold the function setting  , for more than half a second (less than 2 seconds). Now, the battery setting function is completed and the numerical value will light without flash.
- Exit from the setting interface. Press and hold function setting key  for more than half a second (less than 2 seconds), exit from the setting interface and return to main interface.

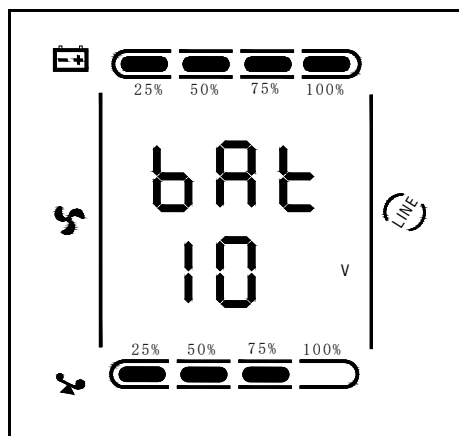

3.7 Parameters Inquiring Operation

Press and hold the inquiring key ◀ or ▶ for more than half a second (less than 2 seconds) to inquire about items. The inquired items include input, battery, output, load, temperature. The displayed items on LCD screen are showed as following:

Output : Display the output voltage and output frequency of the UPS. As the following picture shows, the output voltage is 120V or 220V, the output frequency is 50Hz.

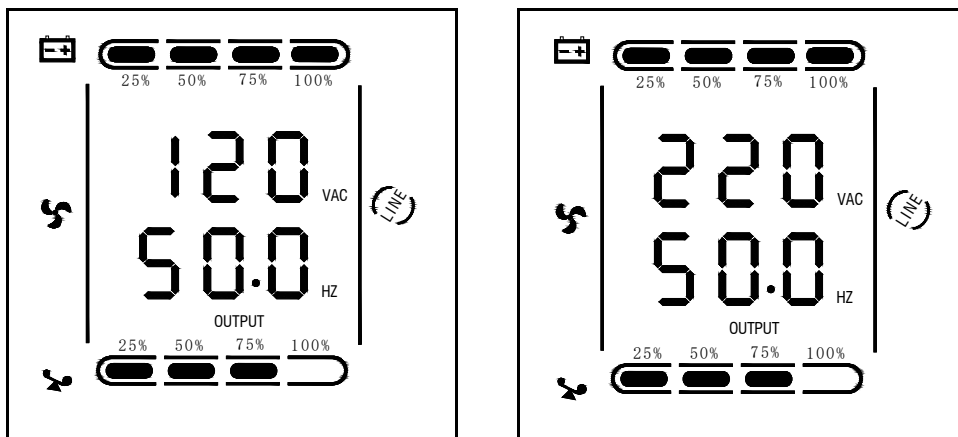

Load: Display the numerical value of the active power (WATT) and apparent power (VA) of the load. For example, as the following graphics shows: the WATT of the load is 800W or 900W, VA is 1000VA (when disconnect load, it is a normal phenomenon to show a small numerical value of WATT and VA). or 900W

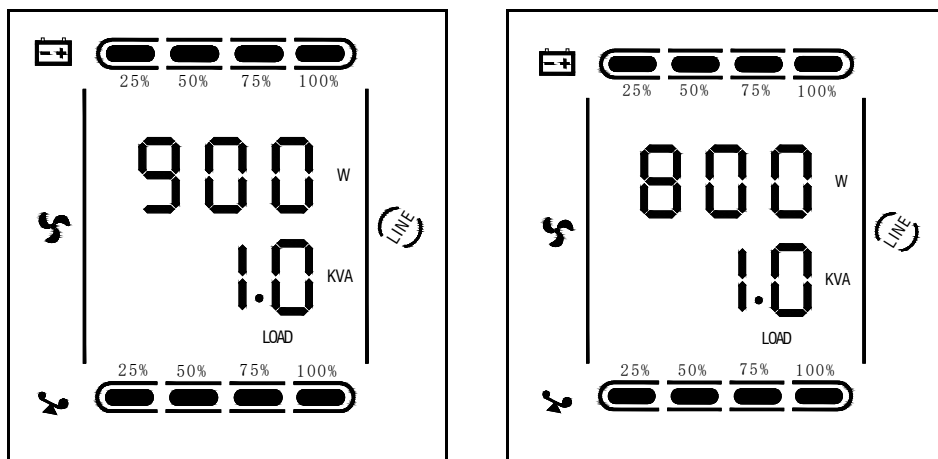

Temperature: Display the maximum temperature of the components in the UPS. As the following picture shows: the maximum temperature is 40℃.

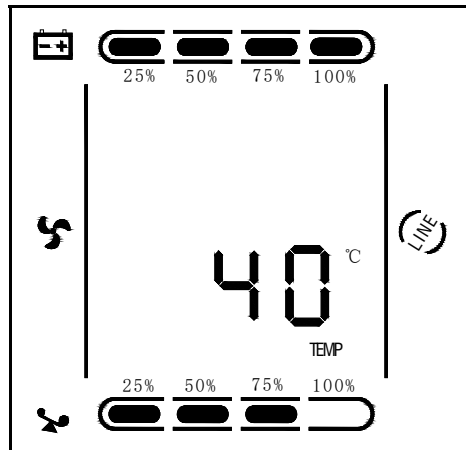

Input: Display the voltage and frequency of the input. As the following picture shows: the input voltage is 120V or 220V, input frequency is 50Hz.

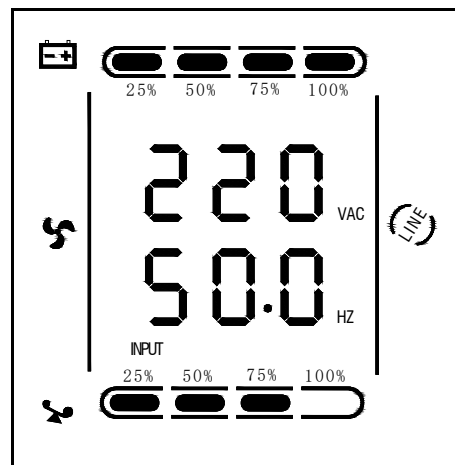
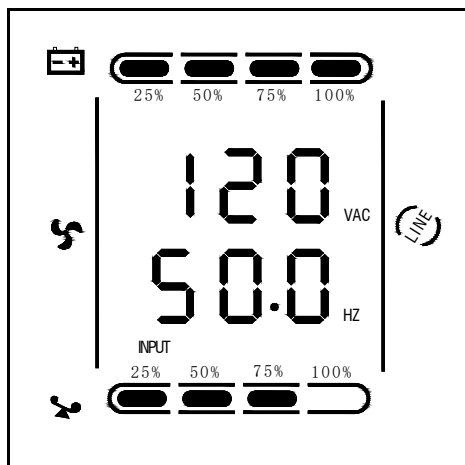

Battery: Display the voltage and capacity of the battery (determined by type). As the following picture shows: the battery voltage is 24V or 36V, the capacity of battery is 100% (the capacity of battery is approximately reckoned according to the battery voltage).

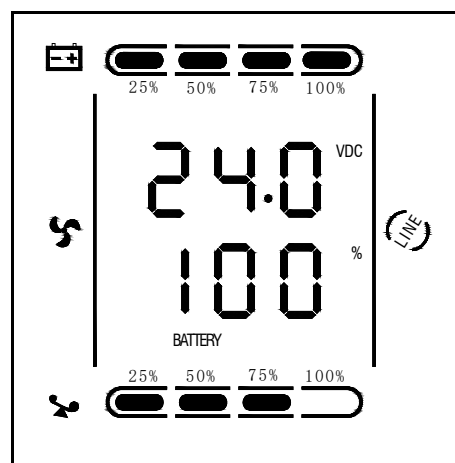
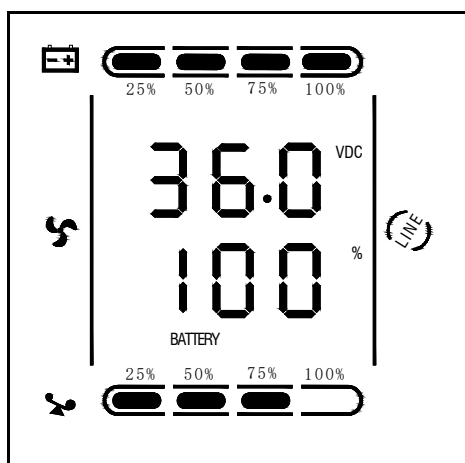

Press and hold the inquiring key ◀ for more than 2 seconds, LCD begins to display the items circularly and orderly which transfer to another every 2 seconds. Press and hold the key for some time again within 30s, it will return to output status.

4 WORKING MODE INTRODUCTION

4.1 Bypass Mode

LED indications on front panel on bypass mode are as following:



Bypass yellow LED is on, the buzzer beeps once every 2 minutes. The warning red LED is on when beeping, LCD displays are according to the exact load and battery capacity.

Turn to bypass mode under the following two conditions:

- Turn off the UPS on line mode while start the bypass output.
- Overload on line mode.

NOTE:

When UPS is working on bypass mode, it has no back up function.

4.2 Line Mode

LED indications on front panel on line mode are as following: The inverter green LED is on.



When input AC is in the range of working conditions, UPS will work on line mode.

4.3 Battery Mode

LED indications on front panel on battery mode are as following: both the inverter green LED and battery yellow LED are on, the buzzer beeps once every 4 seconds. The warning red LED is on when beeping.



When the AC power is low or unstable, UPS will turn to battery mode at once.

4.4 ECO Mode

LED indications on front panel on ECO mode are as following: both the inverter green LED and bypass yellow LED are on.



When the input mains meets the input range of the ECO mode and start the ECO function, the UPS will works on ECO mode. If input AC exceeds the range of ECO several times in a row in a minute but stays in inverter input range, UPS will work on AC inverting mode automatically.

4.5 Fault Mode

LED indications on front panel on Fault mode are as following: warning red LED is on and LCD display fault code and related icon.



Fault mode (LCD interface on which the fault code display)

When UPS has faulted. The warning LED is on and the buzzer beeps. UPS will turn to fault mode. UPS cuts off the output and LCD display fault codes.

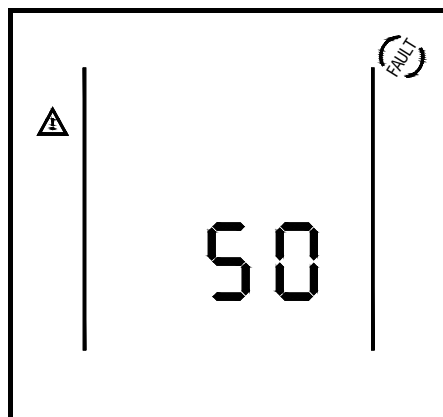

At the moment, you can press the mute key to make the buzzer stop beeping temporarily to wait for maintenance. You can also press the OFF key to shut down the UPS when confirm that there is no serious fault.

5 THE WARNING LIST OF THE LOGHT and DISPLAY PANEL

Appendix 1: The table of the fault code

Fault reason	Fault code
BUS voltage fault	00-14
Power soft start fault	15-24
Inverter voltage fault	25-39
Overheat	40-44
Output short circuit	45-49
Overload	50-54
Input NTC fault	55-59
Power fault	60-64
Input FUSE fault	65-69
Other	88

Appendix 2: Table for working status

S/N	Working status	LED on Front panel				Alarm beep	Note
		Normal	Battery	Bypass	Fault		
1	Inverter mode (mains power)						
	Mains power voltage	•				N	
	Mains power high/low voltage protection, switch to battery mode	•	•		★	One beep / 4 sec	
2	Battery mode						
	Battery voltage - normal	•	•		★	One beep / 4 sec	
	Warning for abnormal voltage of battery	•	★		★	One beep / sec	

3	Bypass mode						
	Mains power – normal (under Bypass)			●	★	One beep / 2 mins	
	Mains power – high voltage warning (under Bypass)			●	★	One beep / 4 sec	
	Mains power – low voltage warning (under Bypass)			●	★	One beep / 4 sec	
4	Warning for battery disconnected						
	Bypass mode			●	★	One beep / 4 sec	
	Inverter mode	●			★	One beep / 4 sec	
	Power on / Switch on					6 beeps	
5	Output overload protection						
	Warning for mains power overload	●			★	2 beeps / sec	
	Protect operation for mains power mode overload			●	●	Long beep	
	Warning for battery overload	●	●		★	2 beeps / sec	
	Protect operation for battery mode overload	●	●		●	Long beep	
6	Warning for bypass mode overload			●	★	One beep / 2 sec	
7	Fans fault(fan icon)	▲	▲	▲	★	One beep / 2 sec	
8	Faults mode				●	Long beep	

- LED Indicator lights long time
- ★ LED Indicator flicker
- ▲ LED indicator status depends on other conditions

Note: Users need to provide below information when require to maintain the UPS.

- UPS Model No. & Serial No.
- Date of fault occurrence.
- Fault detail (LED status, noise, AC power situation, load capacity, for long back up type, battery capacity configuration is also necessary.)

6 TROUBLE SHOOTING

When the system runs in failure mode, the LCD will show as below:

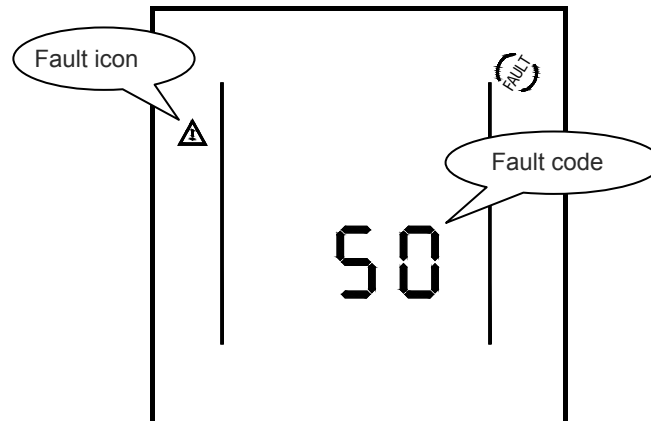

Explicit Troubleshoot Introduction Sheet

Trouble indication	Failure point	Solution
Fault LED on, audible buzzer Persistently alarm, the fault code is 00-14	Bus bar voltage fault	Please test the bus bar voltage or contact the supplier.
Fault LED on, audible buzzer persistently alarm, the fault code is 15-24	Soft start fault	Please check the soft start up circuit, especially the soft start resistance or contact the supplier directly.
Fault LED on, audible buzzer persistently alarm, the fault code is 25-39	Inverter voltage fault	Please contact the supplier.
Fault LED on, audible buzzer persistently alarm, the fault code is 40-44	Over temperature inside	Please make sure the UPS didn't get overload, and the fan vent was not obstructed, as well as the indoor temperature is not high. Leave alone the UPS 10 minutes for cooling, and restart it. If failure remains, please contact the supplier.
Fault LED on, audible buzzer Persistently alarm, the fault code is 45-49	Output short-circuit	Turn off the UPS and disconnect all the load, make sure there no any fault or internal short circuit of the load. And then restart the UPS, if failure still, please contact the supplier.

Fault LED on, audible buzzer persistently alarm, the fault code is 50-54	Over load	Please check the load level and disconnect the noncritical devices, recount the total capacity of your load and reduce the load to the UPS. Please check whether the load device has fault or not?
Fault LED on, audible buzzer persistently alarm, the fault code is 55-59	Input NTC fault	Please contact the supplier.
Fault LED on, audible buzzer persistently alarm, the fault code is 60-64	Power fault	Please Check whether the input & output power normal or not, contact the supplier if it is abnormal.
Fault LED on, audible buzzer persistently alarm, the fault code is 65-69	Input fuse fault	Please check if the input fuse is burnt. Replace the old fuse and restart the UPS. If failure remains, please contact the supplier.
Fault LED on, audible buzzer Persistently alarm, fan icon in the LCD flickers	Fan fault	Please check whether the fans connect well, is the fan plugged and is the fan broken? If all above condition is OK, please contact the supplier.
UPS fail to start when operate "On" key	Pressing time too short	Please press the power key more than 2 seconds to start the UPS.
	The input connection is not ready or UPS internal battery disconnect	Please connect the input well, if the battery voltage is too low, please disconnect the input and start the UPS with no-load.
	UPS internal system fault	Please contact the supplier.
Back up time become short	Battery undercharge	Please keep the UPS battery recharging more than 3 hours.
	UPS overload	Please check the load level and disconnect the noncritical devices,
	Battery maturing, capacity descend	Please change new battery, contact your supplier to get the new battery and spare parts.
UPS doesn't have any power go through even main power on	UPS input breaker disconnects	Please reset the circuit breaker by manual.

ATTENTION: When the output is short-circuited, the action of the protection of the UPS will show up. Before turning off the UPS, please make sure to disconnect the entire load and cut off the AC mains power supply, otherwise will make the AC input short-circuit.

7 ATTENTION BOF BATTERY DISPOSAL

- Please take off your ring, watch and other metals before operate the batteries.
- If you want to change the battery cable, please purchase the material from our local service center or distributors, to avoid heating or spark due to the inadequate power capacity, and even causing fire.
- Don't dispose of the battery or battery pack near or into fire, otherwise it will explode and injure person.
- Don't damage or open the battery case, the battery electrolyte overflow is with highly toxic which is harmful to human.
- Please avoid short circuit between positive and negative terminal, otherwise may cause fire or electric shock.
- Please check the battery voltage before touching. If the loop of battery and loop of input voltage is non-isolated, that will cause high voltage risk between battery terminals and ground.

8 NETWORK COMMUNICATION

This series UPS offer intelligent network interface with a dedicated Ethernet card (optional accessory), realizing network communication and management. For more information about this function, please turn to our local distributor or service center.

9 COMMUNICATION INTERFACE INTRODUCTION

The UPS communicates with PC via analog relay joint and serial interface (RS232). The former transmits the input power and UPS status to PC by choosing "on" or "off" states of transistor. The latter offers communication interface serials with PC to monitor input power and UPS status information, and control the UPS also.

NOTE:

The communication function is only realizable with the specific communion cable from the supplier.

Rs232 interface is set as below:













- Bit rate: 2400bps
- Byte: 8bit
- Completion code: 1bit
- Bit Pattern: None

Appendix 1: EMC Level

The series product is designed to meet the below standard.

EMS	
IEC61000-4-2(ESD)	Level 4
IEC61000-4-3(RS)	Level 3
IEC61000-4-4(EFT)	Level 4
IEC61000-4-5(Suege)	Level 4
EMI	
GB9254-1998/IEC 62040-2	Class B

Appendix 2: Symbol instructions :

Symbols and significations			
Symbol	Significations	Symbol	Significations
	Caution		Protect grounding
	Danger! High Voltage!		Alarm cancel
ON	Turn on		Overload
OFF	Turn off		Battery inspection
	Standby or Shutdown		Repeat
	AC		Display screen repeat key
	DC		Battery

Appendix 3: Specification Sheet

Rated Capacity		1KVA		2KVA		3KVA	
Input							
Rated input voltage		220V or 120V					
Rated input frequency		50Hz/60Hz auto-adaptive					
Input voltage range (the type of 220V)		(115~295)±5VAC (half load) (145~295)±5VAC(full load)					
Input voltage range (the type of 120V)		(55~145) ±5VAC(60% LOAD); (65~145) ±5VAC(70% LOAD) (75~145) ±5VAC(80% LOAD); (85~145) ±5VAC(100% LOAD)					
Input frequency range		45-55Hz+/-0.5% 50Hz type 55-65Hz+/-0.5% 60Hz type					
Input current	220V	8A max	15A max	23A max			
	120V	14A max	27A max	40A max			
PFC		≥0.98					
THDI		< 6%					
Bypass voltage range	220V	Rated output voltage -34V ~ Rated output voltage +32V					
	120V	(95~135) ±5VAC					
Output							
Output voltage	220V	208VAC /210VAC/220VAC/230VAC/240VAC Setting available					
	120V	100/110/115/120/127VAC Setting available					
Output PF		0.8/0.9	0.8/0.9	0.8/0.9			
Output power(Watt)		800/900	1600/1800	2400/2700			
Inverter overload capability		105%~150%: transfer to bypass mode after 30s giving alarm; > 150% : transfer to bypass mode after 300ms giving alarm;					
Voltage accuracy		±0.2					
Load crest		3:1					
From AC mode to BAT mode		0ms(transfer time)					
From BAT mode to AC mode		0ms(transfer time)					
Efficiency	LINE mode	≥90 % (full load)					
	BAT mode	87%					
	ECO mode	98%					
Output frequency							
Under Mains mode		Same as input frequency					
Under battery mode		(50/60±0.2)Hz					
Phase-locked rate		≤1Hz/s					
Total voltage harmonic distortion		Full linear load< 3% ; Full nonlinear load< 5%					
Battery							
Battery type		Sealed lead acid maintenance free battery					
Quantity		2	3	4	6	6	8
DC voltage		24V	36V	48V	72V	72V	96V
Inbuilt battery		9AH/12V	7AH/12V	9AH/12V	7AH/12V	9AH/12V	7AH/12V
Output voltage		27.1±0.4V	40.6±0.5V	54.2±0.6V	81.3±0.9V	81.3±0.9V	108.4±1V
Back up time		Based on battery capacity					
Charge method		Three-stage charging					
Charge current		Standard model :1A Long time model: 6A					
System Control and Communication							
Function		Silence; cold start; AC restart; Auto restart.					
Protection		Over-temp protection; Fan testing protection; AC L and N reversely connecting protection; Output short circuit protection					
Communication port		RS232; SNMP card; USB					
Software function		Graphics analyze; Switch on/off UPS system; Monitor UPS working status; History record and event log					
Display		LCD/LED					

Appendix 4: Specification Sheet (6-10KVA)

Rated Capacity		6KVA		10KVA	
Input					
Rated input voltage	220V				
Rated input frequency	50Hz/60Hz auto-adaptive				
Input voltage range	(115~295)±5VAC (half load); (145~295)±5VAC(full load)				
Input frequency range	45-55Hz+/-0.5% 50Hz type				
	55-65Hz+/-0.5% 60Hz type				
Input current	46A max		76A max		
PFC	≥0.99				
THDI	< 5%				
Bypass voltage range	Rated output voltage -34V ~ Rated output voltage +32V				
Output					
Output voltage	208VAC /210VAC/220VAC/230VAC/240VAC Setting available				
Output PF	0.8	0.9	0.8	0.9	
Output power(Watt)	4800	5400	8000	9000	
Inverter overload capability	105%~125%: 10 mins; 125%~150%: 30 secs; > 150%: 100ms;	105%~125%: 3 mins; 125%~150%: 30 secs; > 150%: 100ms;	105%~125%: 10 mins; 125%~150%: 30 secs; > 150%: 100ms;	105%~125%: 3 mins; 125%~150%: 30 secs; > 150%: 100ms;	
Voltage accuracy	±0.2				
Load crest	3:1				
From AC mode to BAT mode	0ms(transfer time)				
From BAT mode to AC mode	0ms(transfer time)				
Efficiency	LINE mode	≥92% (full load)			
	BAT mode	90%			
	ECO mode	98%			
Output frequency					
Under Mains mode	Same as input frequency				
Under battery mode	(50/60±0.2)Hz				
Phase-locked rate	≤1Hz/s				
Total voltage harmonic distortion	Full linear load< 3% ; Full nonlinear load< 5%				
Battery					
Battery type	Sealed lead acid maintenance free battery				
Quantity	16				
DC voltage	192V				
Output voltage	216.8±1V				
Inbuilt battery	16*9AH/12V				
Charge method	Three-stage charging				
Back up time	Based on battery capacity				
Charge current	Standard model:1A				
	Long time model: 1A /3A /5A /8A				
System Control and Communication					
Function	Silence; cold start; AC restart; Auto restart.				
Protection	Over-temp protection; Over-temp protection; Fan testing protection; AC L and N reversely connecting protection; Output short circuit protection				
Communication port	RS232; SNMP card; USB				
Software function	Graphics analyze; Switch on/off UPS system; Monitor UPS working status; History record and event log				

Display	LCD/LED
---------	---------

Appendix 5: Physical (The type of 220V)

Rated Capacity		1KVA		2KVA		3KVA		
Dimension (W*D*H)	UPS	Long	440×468×88					
		Standard	440×468×88 (With Internal battery)	440×468×88 (Without Internal battery) 440×640×88 (With Internal battery)				
	Battery pack	440×468×88						
Quantity of Battery		2	3	4	6	6	8	
Weight (Kg)	Long		6		12		13	
	Standard	WOIB	/		12		13	
		WIB	12	14.5	28	33	33	/
	Battery pack		/	17	23	23	28	

* WOIB: Without Internal battery

* WIB: With Internal battery

Rated Capacity		6KVA		10KVA		
Dimension (W*D*H)	UPS	440×565×132				
	Battery pack	440×565×132				
Weight (Kg)	Long		19		19	
	Standard		19		19	
	Battery pack		52		52	

Appendix 6: Physical (The type of 120V)

Rated Capacity		1KVA		2KVA		3KVA		
Dimension (W*D*H)	Long		440×468×88					
	Standard		440×468×88 (With Internal battery)	440×468×88 (Without Internal battery) 440×690×88 (With Internal battery)				
	Battery pack		440×468×88					
Weight (Kg)	Long		6		12		13	
	Standard	WOIB	/		12		13	
		WIB	12		28.5		33.5	
	Battery pack		/		17		23	

* WOIB: Without Internal battery

* WIB: With Internal battery

Appendix 7: Communication port

- Communication port for PC

At the rear panel of this model, there is one DB9 port, which provides several signals as follows:

Foot	Explanation	Foot	Explanation
1	empty	6	empty
2	Send	7	empty
3	receive	8	empty
4	empty	9	awaken
5	GND		

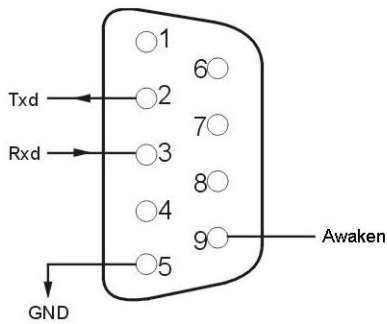

Communication port for PC

- TCP/IP

This model UPS can supply one Intelligent Slot at the rear panel, which was compatible with most of the software and hardware all of the world, such as running HP open view, IBM net view, SUN net manager and other operation system. UPS is with function login on internet supplying information of UPS status and input power, and even capable of controlling UPS via net management system.

For more information, please turn to local supplier or distributor.

10 GUARANTEE

10.1 Terms of Guarantee

- Our products are under a two-year guarantee starting from the date of delivery against malfunctions resulting from production, material and workmanship faults. Malfunctions due to such type of faults will be removed without claiming any price of workmanship or spare parts to be replaced.
- Whether aforementioned malfunctions originate from usage faults or not are determined with a report to be issued by service stations, if there exists no service stations, by one of seller, dealer, agency, representative, importer or manufacturer or producer of those products respectively.
- Repair time of defective products is twenty business days at most. This period starts from the date when products are delivered to one of seller, dealer, agency, representative, importer or one of manufacturer or producer. Provided that products break down within the period of guarantee, the time passing during the repair process is added to the guarantee time. Provided that faults of products cannot be removed within ten business days, manufacturer-producer or importer is obliged to assign another product having similar features for the use of consumers until the faulty product has been repaired.
- Even though consumers exercise their repair rights, they can claim free replacement of products, refund or price discount at the rate of fault in the events;
 - That, besides, the product, as of the date when the product is delivered to the consumer, breaks down four times a year or six times within the guarantee period to be determined by the manufacturer-producer and/or importer at least, on the condition of being in guarantee period, such malfunctions perpetuate passing over;
 - That maximum time required for the repair of products is exceeded;
 - That repair of the malfunction is determined as impossible through a report to be issued by service station, if there exists no service station, one of seller, dealer, agency, representative, importer or manufacturer or producer of the company respectively.
- The consumer is, on demand, obliged to submit guarantee certificate in terms of repairs or replacements within the scope of guarantee.
- It is essential that you definitely perform damage control over external packaging before receiving the products to be sent through freight. In the event of any damage, delivery

person must be made to prepare a “damage determination record”. (For example; during the delivery process, the product has been checked and seen that is damaged.)

- After the damage determination record has been issued, we request you to inform the MAKELSAN head office of the case. Products to be received from freight by signature means that products have been received completely and without no damage.
- Repairs of plug-and-play products in the places where no service point is around are performed in the factory of MAKELSAN or the nearest service point according to the direction to be made by the MAKELSAN head office. Defective product is delivered by hand to the nearest service point or to the contracted freight company in its original packaging to be sent to the factory of MAKELSAN according to the direction to be made by the MAKELSAN head office. For malfunctions in the scope of guarantee, shipment fees are under the responsibility of MAKELSAN on the condition that products are delivered to the contracted freight company.
- The device must be sent as packed in its original packaging as long as it is not desired by the service. Original packaging of devices should be preserved in order to use them for shipment of devices in terms of repairs to occur. Otherwise, no responsibility is assumed with regards to any troubles to be experienced.
- All defective products to be delivered by hand or through freight are to meet the necessary shipment requirements. (Anti-static protective, bubble wrap or box etc.) It is essential that legible barcode serial number belonging to the product be on the product. Otherwise, it is not covered in the scope of the guarantee.
- It is essential that products to be sent through freight definitely be together with delivery note, and that serial/model/malfunction details be written on delivery note to be sent (for example, breakdown report form), and that packaging content match with the products specified in the delivery note. Otherwise, freight is not accepted.
- The use of the Guarantee Certificate, submitted together with products with MAKELSAN trademark, is permitted by the T.R. Ministry of Industry and Commerce and General Directorate of Protection of Competition with no..... in accordance with the law, with no. 4077, and the notification, with no. TRKGM-95/116-117, issued basing the aforementioned law. MAKELSAN acknowledges and undertakes to obey the liabilities determined by the laws and legislations.

10.2 Cases Not Covered by the Guarantee

- Breakdowns resulting from the use of products contrary to the issues or the environment conditions (temperature, humidity etc.) specified in the user manual are not covered in the scope of guarantee.
- Damages and breakdowns resulting from the use of software, hardware, interface, accessories or consumables apart from those used together with products or recommended ones; changing place, wrong and insufficient maintenance, calibration or

use; its operation contrary to environment specifications published for products; insufficiency of air installation; use of products in ambient having excessive humid or temperature; its operation in environment harmful for electrical circuits and abrasive; and accidents, impacts, electric, shipment, natural disasters, not limited to the ones listed above, are not covered in the scope of product guarantee.

- In the general examination performed during the breakdown acceptance process, certain troubles causing products not to be covered in the scope of guarantee might not be understood. Provided that such faults come up in the detailed examination to be performed via technical service equipment, products are returned to customers.
- Products not covered in the scope of guarantee can, on demand of customer, be treated in a fee-paying way within the bounds of possibilities of the authorized service. Products out of the scope of guarantee, repairs of which are not possible are returned to customers.
- Damages and breakdowns resulting from treatments, internally or externally tampering, efforts to repair and spare part replacement of products, without approval of MAKELSAN, and those resulting from treatment of unauthorized service/dealer/person/establishment, are not covered in the scope of guarantee. Breakdown, cracks, scratches and wear, corrosion and dust to occur in time and by use in the outer surfaces of products (cabinet, cover, and front panel) are not covered in the scope of guarantee.
- In the event that original serial numbers, guarantee labels and stamps on products are removed or distorted, products are not covered in the scope of guarantee. No guarantee is issued against the use of products for any other purpose, apart from those specified in introduction or manual of products.
- Shelf lives of VRLA batteries are 6 months under the ambient temperature of 15 °C and 3 months under the ambient temperature of 25 °C.
- It is compulsory that systems to be purchased be commissioned within 3 months.

11 CONTACT INFORMATION



www.makelsan.com.tr

Headquarter: İstanbul Deri Organize Sanayi Bölgesi 2. Yol I -5 Parsel 34956 Tuzla/ İstanbul

Tel : 0216 428 65 80

Fax : 0216 327 51 64

E-mail : makelsan@makelsan.com.tr

İzmir Office : Halkapınar Mah. 1348 Sok. 2AE Keremoğlu İş Merkezi Yenişehir – İzmir

Tel : 0232 469 47 00

Fax : 0232 449 47 00

E-mail : izmir@makelsan.com.tr

Ankara Office : Mustafa Kemal Mah. 2157 Sok. No:4/6 Çankaya-Ankara

Tel : 0312 219 82 35/37

Fax : 0312 219 82 36

E-mail : ankara@makelsan.com.tr

MAKELSAN®

Uninterruptible Power Supplies

www.makelsan.com.tr

Headquarter: İstanbul Deri Organize Sanayi Bölgesi 2. Yol I -5 Parsel 34956 Tuzla/ İstanbul

Tel : 0216 428 65 80

Fax : 0216 327 51 64

E-mail : makelsan@makelsan.com.tr

İzmir Office : Halkapınar Mah. 1348 Sok. 2AE Keremoğlu İş Merkezi Yenişehir – İzmir

Tel : 0232 469 47 00

Fax : 0232 449 47 00

E-mail : izmir@makelsan.com.tr

Ankara Office : Mustafa Kemal Mah. 2157 Sok. No:4/6 Çankaya-Ankara

Tel : 0312 219 82 35/37

Fax : 0312 219 82 36

E-mail : ankara@makelsan.com.tr