

MAKELSON[®]

Uninterruptible Power Supplies

USER MANUAL

LEVELUPS SERIES

300-400-500 KVA

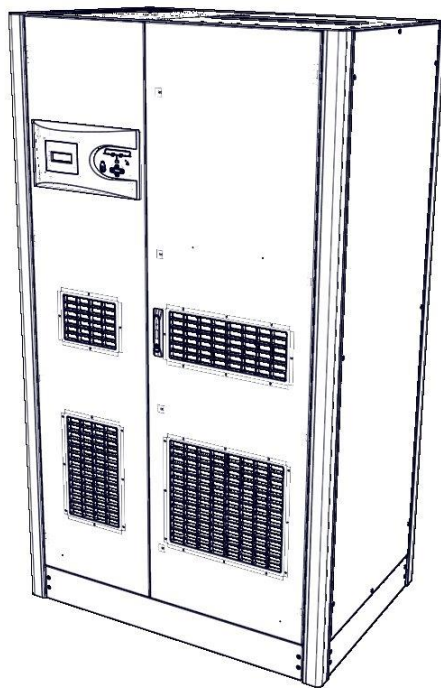

USER MANUAL

LEVELUPS SERIES

300-400-500 KVA

GM-SD-24

Rev:1

About the Manual

This Manual is prepared for the users of LevelUps Series 300 - 400 - 500 kVA.

Companion Manuals

For more info about this device and its options, please visit www.makelsan.com.tr

Updates

Visit www.makelsan.com.tr for updates. Always use the latest manual.

Shipment

Carrying vehicles or handling accessories must have enough features and characteristics to carry UPS's weight.



DO NOT LIFT HEAVY DUTY WEIGHT WITHOUT HELP

1 Person	<18 kg (<40 lb)
2 People	18-32 kg (40-70 lb)
3 People	32-55 kg (70-120 lb)
Carrying vehicles or handling accessories	>55 kg (>120 lb)

Be more careful of sudden movements, especially when batteries are inside of cabinet.



CONTENTS

- Shipment i
- 1 SAFETY AND WARNINGS 4
 - 1.1 Warnings 4
 - 1.2 Clearance and Access 5
 - 1.3 Storage 5
 - 1.4 Shipment 5
- 2 PRODUCT DESCRIPTION 7
 - General View 7
 - 2.1 General Information 12
 - 2.1.1 Static Transfer Switch 12
 - 2.1.2 Battery Temperature Regulation 13
 - 2.2 UPS’s Operation Modes 13
 - 2.2.1 Normal (Online) mode 13
 - 2.2.2 Battery (Stored) Mode 13
 - 2.2.3 Bypass Mode 13
 - 2.2.4 Auto Restart Mode 14
 - 2.2.5 Maintenance Mode 14
 - 2.3 Battery Management 14
 - 2.3.1 Normal Operation Mode 14
 - 2.3.2 Advanced Functions (Battery tests) Auto Battery Test 15
 - 2.3.3 Common Battery 15
 - 2.4 User Panel 16
 - 2.4.1 Opening Screen 18
 - 2.4.2 Main Menu Screen 18
 - 2.4.3 Navigation through the menu 18
 - 2.4.4 Password-protected menus 19
 - 2.4.5 Control Menu 19
 - 2.4.6 Status Menu 20
 - 2.4.7 Setup Menu 21
 - 2.4.8 Logging Menu 23
 - 2.4.8 Service Menu 24
- 3 INSTALLATION 25

- 3.1 Single Module Installation 25
 - 3.1.1 Warnings..... 25
 - 3.1.2 Pre-installation check up 26
 - 3.1.3 Positioning 26
 - 3.1.3.1 Positioning The UPS..... 26
 - 3.1.3.2 External Battery Configuration 27
 - 3.1.4 Transportation Type of Cabinets 29
 - 3.1.5 Mains, Load and Battery Connections 29
 - 3.1.5.1 External Protection 29
 - 3.1.5.2 Cabling and fuse configuration..... 30
 - 3.1.5.3 Cable connections 30
 - 3.1.5.4 Battery connections 34
 - 3.1.5.4.1 External Battery Installation Procedure and Connection 34
 - 3.1.5.5 Control and Communication Cable Connections 37
- 3.2 Parallel Installation 37
 - 3.2.1 Parallel Settings 39
- 4 OPERATION 40
 - 4.1 Operation Procedure 40
 - 4.1.1 Circuit Breakers 40
 - 4.1.2 First start-up 41
 - 4.1.3 UPS Operation Modes Testing 44
 - 4.1.3.1 Switching from Online Mode to Battery Mode 44
 - 4.1.3.2 Switching from Online Mode to Static Bypass Mode..... 44
 - 4.1.3.3 Switching from Static Bypass Mode to Online 45
 - 4.1.3.4 Switching from Online Mode to Maintenance Bypass Mode..... 45
 - 4.1.5 EPO(Emergency Power OFF) 49
 - 4.1.6 RS232 Serial Communication Installation and Investigation 49
- 5 EXPLANATIONS of LOGGING..... 50
- 6 Table of Technical Specifications..... 54
- 7 CONTACT INFORMATIONS 56

1 SAFETY AND WARNINGS

1.1 Warnings

This manual must be read before installing the UPS. The device can be installed and started only by Makelsan authorized personnel.

Installation or start-up by unauthorized personal may cause damage to the device and serious injury or death.

The UPS is designed to be used in continuous vertical fixed position applications.



THE UPS MUST BE USED WITH GROUND CONNECTION.

Connect the ground cable before connecting the mains.

Ground currents may be as high as 0.4A



THE UPS MUST BE DISCONNECTED FROM THE MAINS AND BATTERIES BEFORE SERVICING. ALSO WAIT FOR AT LEAST 5 MINUTES FOR THE DC BUS CAPACITORS TO DISCHARGE AFTER POWER OFF. AND THE SERVICE SHOULD BE COMPLETELY CHECKED IS DRAINED.

Service-Maintenance

All servicing and maintenance is done internally. All parts in the device can be serviced and replaced only by a trained technician.



PREVENTATIVE MAINTENANCE IS RECOMMENDED AT LEAST ONCE A YEAR FROM THE INSTALLATION BY AUTHORIZED TECHNICAL PERSONNEL. (THIS SERVICE WILL BE PROVIDED FOR A FEE BY OUR AUTHORIZED MAKELSAN PERSONNEL.)



BATTERY VOLTAGE MAY RISE UP TO 450V DC!

Battery terminal voltages can be at hazardous levels (450Vdc). Nobody except trained personnel should touch batteries.

Batteries must not be thrown into fire. The damaged batteries and batteries with completed life cycle must not be thrown to nature. For the collection and disposal batteries must delivered to MAKELSAN authorized technicians or to the foundations which are authorized for collecting waste batteries by the Ministry of Environment.

Fire extinguishing equipment must be kept nearby the UPS.

1.2 Clearance and Access

Clearance

There is no any air inlet or outlet grill on the left or right sides of our 300 – 400 – 500 kVA UPS. All air goes in to UPS from the front and behind. Air is evacuated from the top fans. There must be spaces at least 1 meter for UPS's front side and back side. Should not be permanent or temporary use within the limits specified. Otherwise, the UPS performance will decrease.

Access

Operator reaches UPS via front panel on 300 - 400 – 500 kVA UPS. Therefore, enough area must be left for operator. Also, UPS can be intervened in the back of it for service and maintenance. Because of this reason, enough area for personal must be left at the rear side of UPS. There are no limitations on the sides of the UPS.

1.3 Storage

UPS should be kept in a room or area where is protected from excessive moisture and heat before commissioning. UPS and battery cabinets must be kept in the original packaging.

Environment where the device is used for powder, iron powder, oil etc. It should be selected to be affected by production waste.



UNUSED BATTERIES MUST BE CHARGED AT REGULAR INTERVALS. THIS TIME INTERVAL ARE DETERMINED BY THE BATTERY MANUFACTURER. CHARGING CAN BE PERFORMED PERIODICALLY BY CONNECTING TO A PROPER MAINS FOR A WHILE.

1.4 Shipment

Carrying vehicles must have be equipped properly and have features and characteristics sufficient to carry UPS.

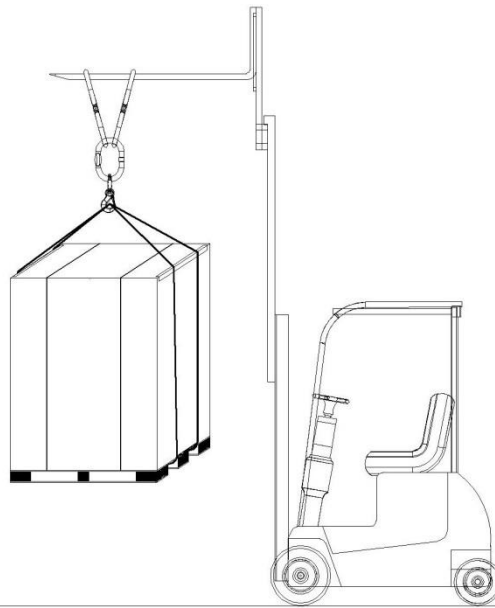

3L100120R002R0

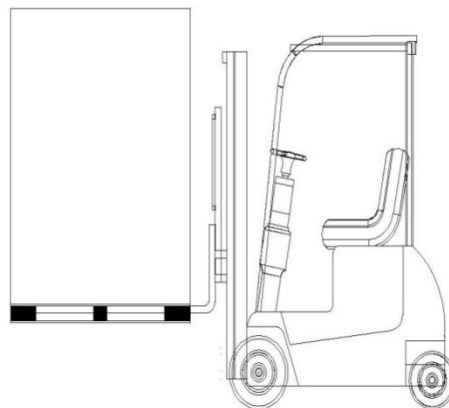

3L100120R003R0

The UPS device shipment must be done on pallets.

Be more careful of sudden movements, especially when batteries are inside of cabinet. Move the UPS as rarely as possible

2 PRODUCT DESCRIPTION

General View

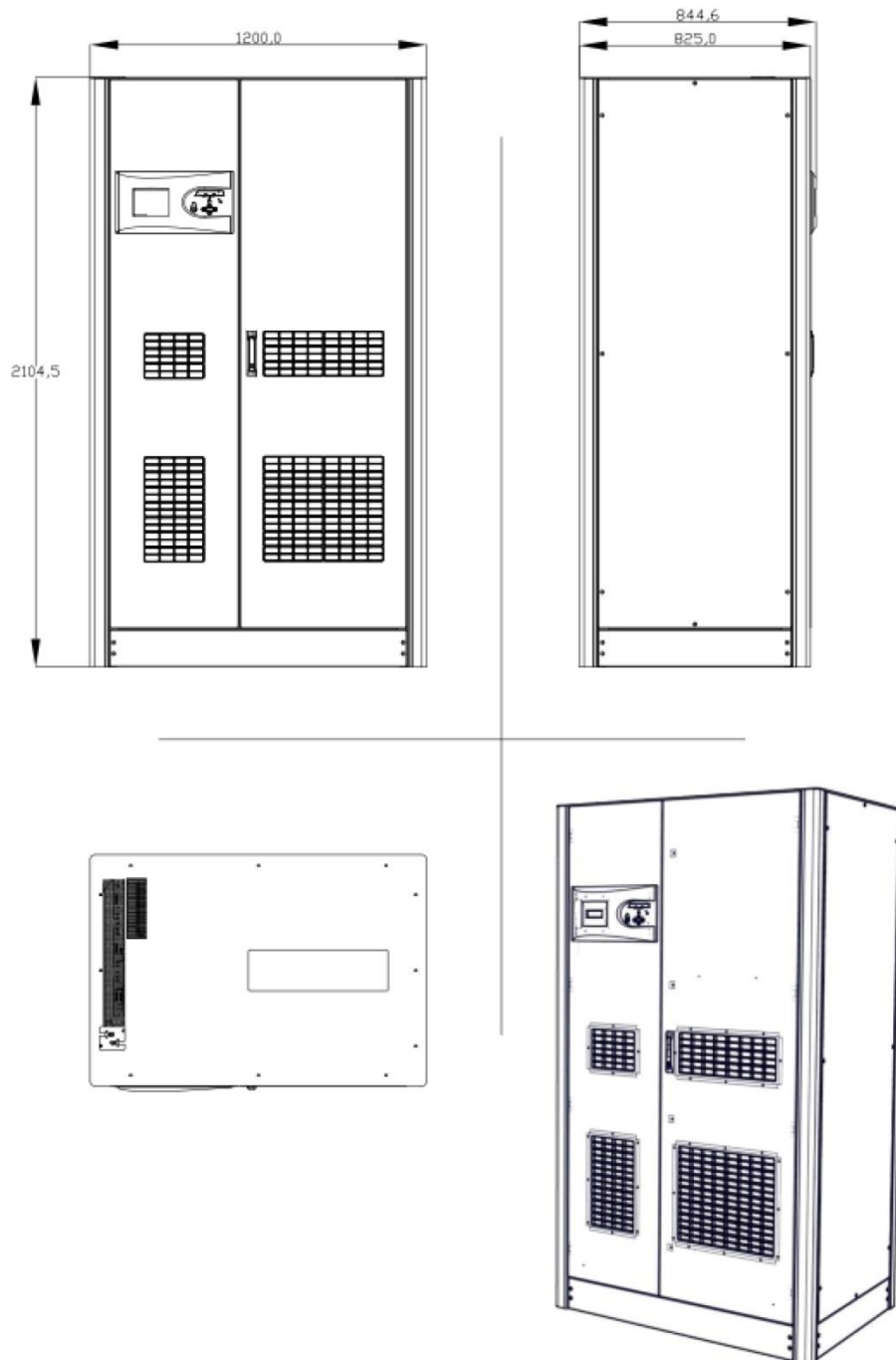

Front View

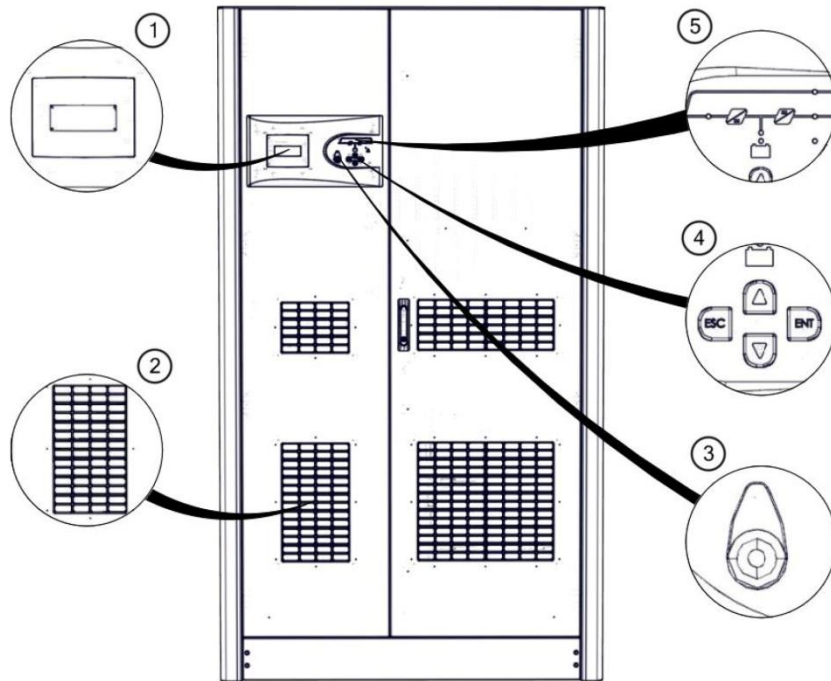

1	LCD Display
2	Fresh Air Grids
3	EPO button
4	Menu Keys
5	Mimic Diagram

Front Panel View

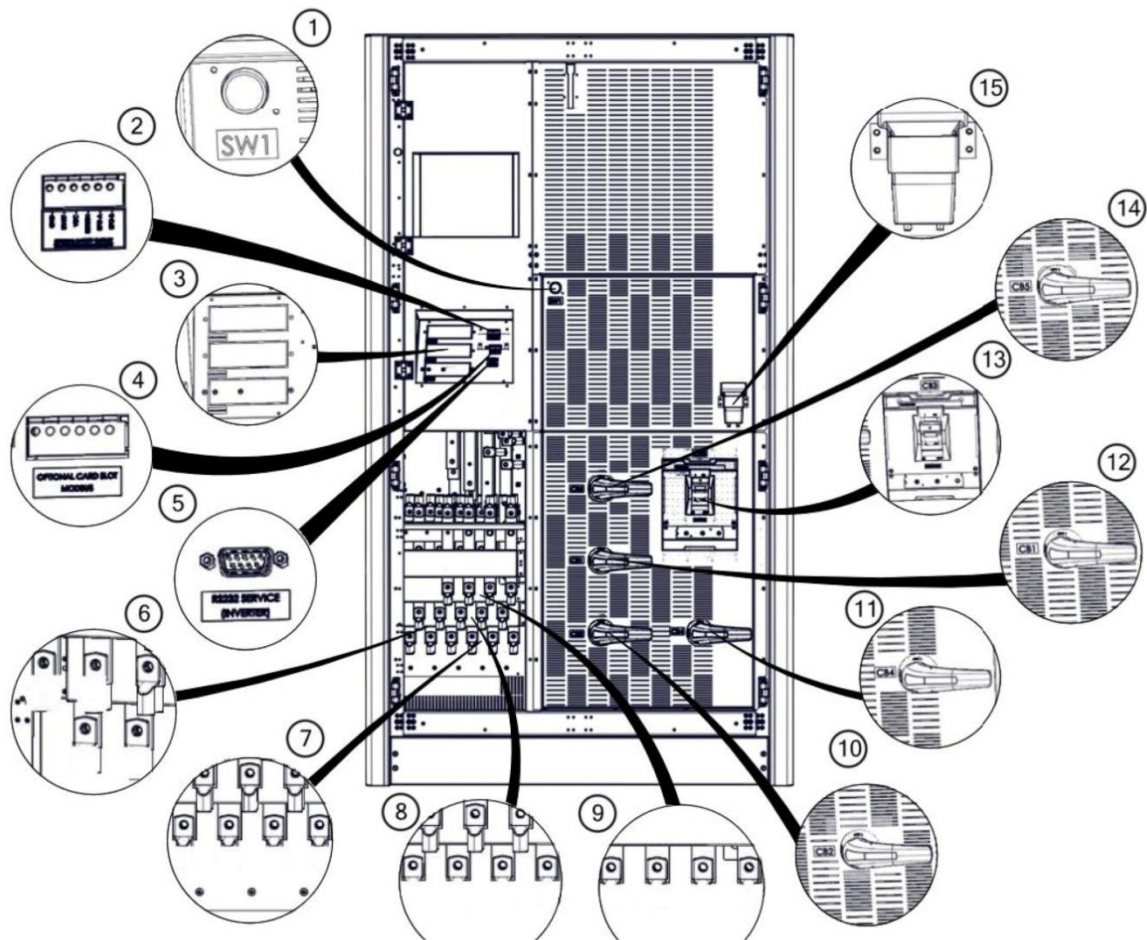

1	DC Bus Ramping up Button	9	External Bypass Terminals
2	External Battery Temperature Reading	10	Bypass Connection Switch - CB2
3	Optional Card Slots	11	Battery Start-up Switch - CB4
4	Modbus Card Slots	12	Mains Switch - CB1
5	RS232 Terminal for Communication Software	13	Output Switch - CB3
6	External Battery Connection Terminals	14	External Bypass Switch - CB5
7	Output Connection Terminals	15	Output Switch Handle
8	Mains Connection Terminals		

Top View

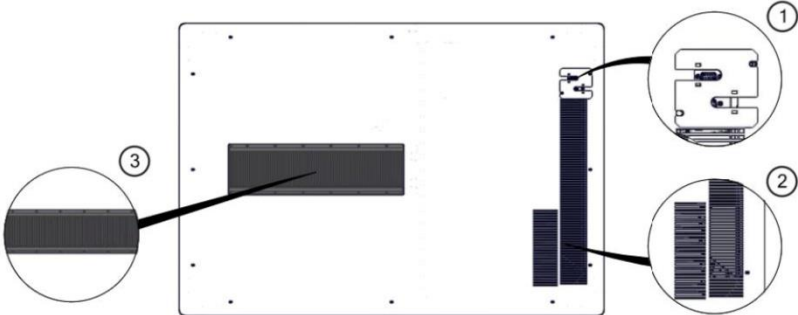

1	Parallel Port Terminal
2	Wiring and Thyristor Hot Air Evacuation Channel
3	Rectifier, Inverter and Charger Hot Air Evacuation Channel

Electrical Connection

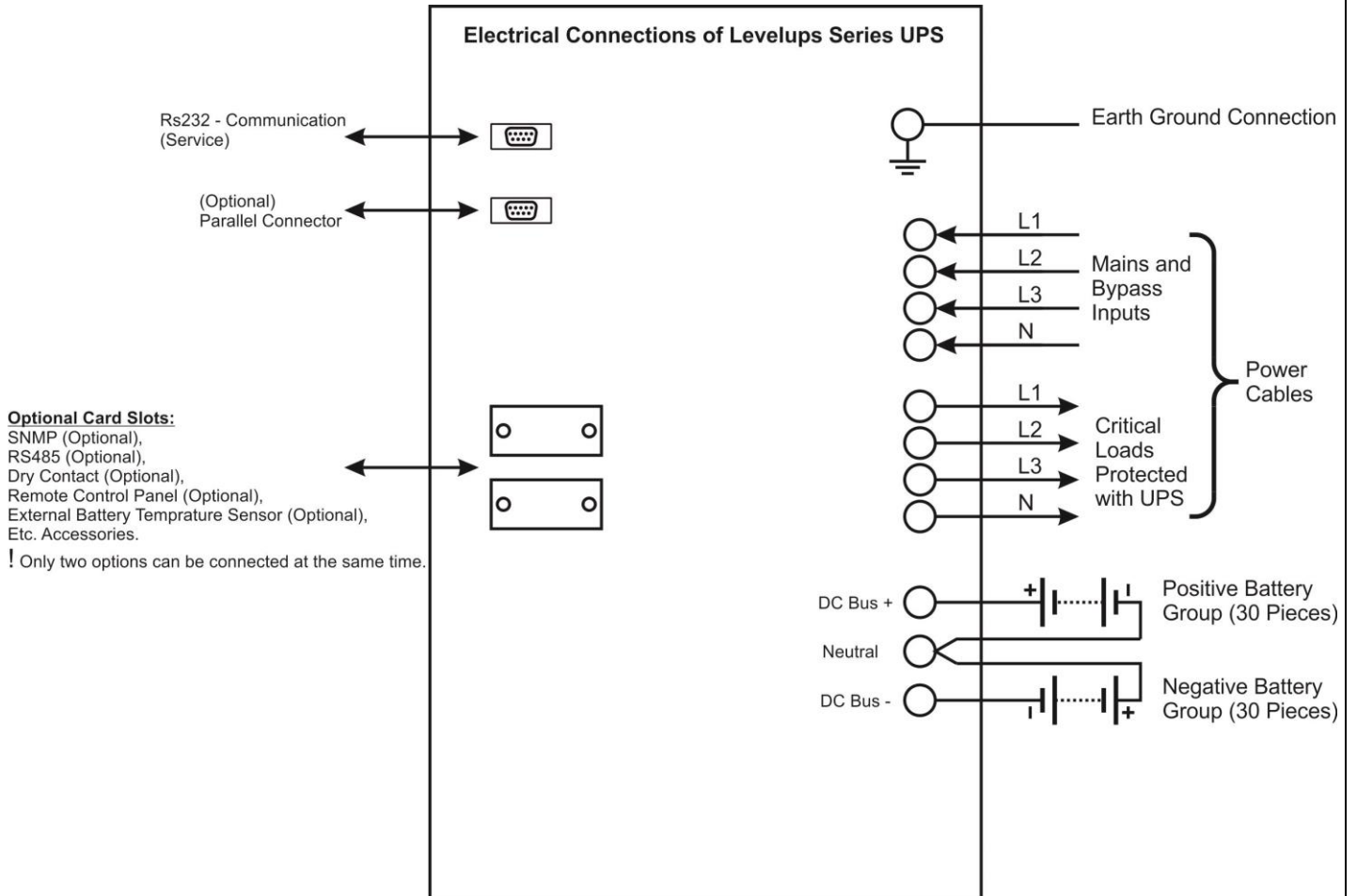

2.1 General Information

General operation topology of LevelUps Series can be recognized as follows:

MAKELSAN® ELECTRICAL TOPOLOGY OF LEVELUPS SERIES UPS

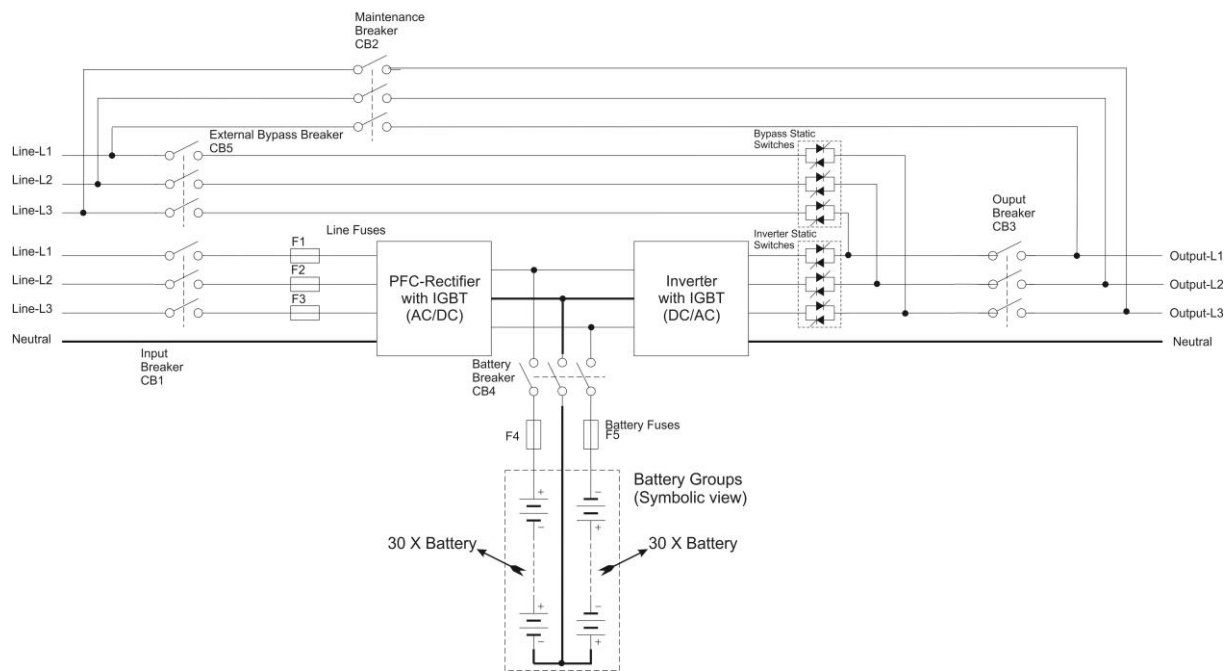

The UPS or power (CB1) enters through the key. (CB1) before you switch to the ON position (SW1) button is held down for at least 10 seconds. Then (CB1) will be the key to the ON position. Enter the product operated from the front panel to the Control-Password-Run menu. Rectifier converts the AC mains to DC voltage and charges the batteries. When the mains voltage is not available, the necessary the DC bus voltage is generated with use of the battery voltage. DC DC bus voltage is then converted to mains synchronized AC voltage by the inverter. This is a high quality voltage. Generated AC power is applied to loads through the static semi-conductor switches and output (load) breakers.

When maintenance or repair is needed, before the Input (CB1) and Output switches (CB3) are put to the open circuit (OFF) position, the device must be switched to static bypass mode (please see 4.1.3.2). Consequently the maintenance switch (CB2) is put to the position closed circuit (ON). After that first Output breaker (CB3), then Input switches (CB1) are turned OFF respectively.

2.1.1 Static Transfer Switch

Some blocks are named as “static switches” as can be seen above. These blocks consist of inverse parallel connected thyristors. Controlled by the main board control unit (DSP) these switches provide feeding of the loads through either mains or inverters. The loads are supplied through

inverter during the normal operating mode. Therefore, Inverter static switches are active if there are no problems with the system.

System provides the loads to be fed smooth and seamless by mains or inverter. In order to manage this process at minimum risk, UPS synchronizes the inverter output and static (mains) bypass as phase and frequency. Therefore, Inverter frequency can be considered same with mains as long as it is within frequency limit.

User can switch between mains and inverter by using front panel. When the inverter is ready, while the loads are fed through the bypass line, in case of either power failure or if mains values are out of tolerances, the loads automatically will be fed through the inverter.

2.1.2 Battery Temperature Regulation

In the external battery cabinets the battery temperature is measured and detected by "temperature sensor". UPS adjusts battery charge parameters according to the detected temperature.

2.2 UPS's Operation Modes

LevelUps series is on-line double conversion device. Our products operate in the following modes:

- Online Mode
- Battery Mode
- Bypass Mode
- Auto Restart
- Maintenance Mode

2.2.1 Normal (Online) mode

In this mode, UPS feeds the load through the inverters. Rectifier unit is fed by the AC mains power. Inverter and battery charge units are fed by DC supply generated by rectifier unit.

2.2.2 Battery (Stored) Mode

When the mains voltage is bad the UPS runs on battery mode. UPS feeds the critical load through the inverter; the energy is obtained from batteries.

2.2.3 Bypass Mode

In case when UPS is overloaded or if inverter cannot generate a quality AC output due to any problem and if bypass voltage and frequency values are within the limits, the loads will be fed from the static bypass source (mains). UPS without interruption switches from inverter to AC source (mains) via static transfer switches. The inverter source and mains must be synchronized

in order to manage smooth switching. If inverter output and mains are not synchronized, switching may take up to 15 msec, varying according to load type.

2.2.4 Auto Restart Mode

In case of any failure of the mains, UPS will continue feeding the critical loads until the batteries will reach the end of discharge voltage level. UPS will be working until the batteries are drained and then will shutdown. When mains are restored to normal conditions UPS automatically will start its operation, in the period determined by the user. UPS continues to operate in normal (online) mode as long as the mains values are within desired limits. For LevelUps Series, this feature is not activated in the initial factory set-up.

2.2.5 Maintenance Mode

On the maintenance mode loads are switched to the maintenance bypass line with a breaker, so that the UPS can be serviced without cutting off the power to loads. The breaker is in full conformity with capacity of loads.

2.3 Battery Management

Lead-acid batteries are used.

2.3.1 Normal Operation Mode

Constant Charge Current

Constant current at 1/10 rate of the battery capacity is applied to battery, until it reaches the float voltage.

Float Charge

Depending on the battery discharge current the 1/3 of the battery energy is charged at this level. With this level of charging batteries are kept ready for use at maximum capacity. For lead-acid batteries, this voltage varies between values 2.2-2.35 V/cell. This voltage may differ slightly with temperature adaptation. Option of setting this coefficient is provided with our UPS, we recommend using the temperature sensor.

Deep Discharge Protection

While the system is operating in the battery mode, if battery voltage has dropped below the discharge level UPS shuts down and stops taking energy from the batteries. This value varies between 1.6-1.75 V/cell for Lead-Acid batteries, and between 0.9-1.1 V / cell for Ni-Cd batteries.

Low Battery Warning

While the system operates on battery (stored) mode, according to actual loads, if the battery capacity drops below 40% of its value, device will give audible and visible alarms. This value is adjustable and can be set by user between 20%-70%.

2.3.2 Advanced Functions (Battery tests) Auto Battery Test

The auto battery test discharges 10% of the battery energy in a user defined period. Default is 90 days. Test reports the battery condition as good, weak or replace. Results of the latest test can be seen on the battery screen from the status menu.



IF THE TEST RESULT IS “REPLACE”, THEN BATTERIES ARE COMPLETELY DRAINED DURING THE TEST. THIS MAY CAUSE THE INTERRUPTION IN THE POWER SUPPLY TO THE CRITICAL LOADS IN CASE OF THE MAINS FAILURE.

This test command can be given from front panel monitor, via TELNET interface, via RS232 smart communication or via UPSMAN (SNMP, see the options).

The purpose of the battery test is to check if the batteries can supply the minimum back-up time needed in case of mains failure. We recommend checking the test results on the regular basis.

2.3.3 Common Battery

Two products running in parallel in our Levelups products can share a common battery group. No additional equipment needed. Consult Technical Service for details of the work.

2.4 User Panel

User panel consists of mimic diagram, LCD screen, EPO button and menu keys. The UPS can be controlled via this panel.

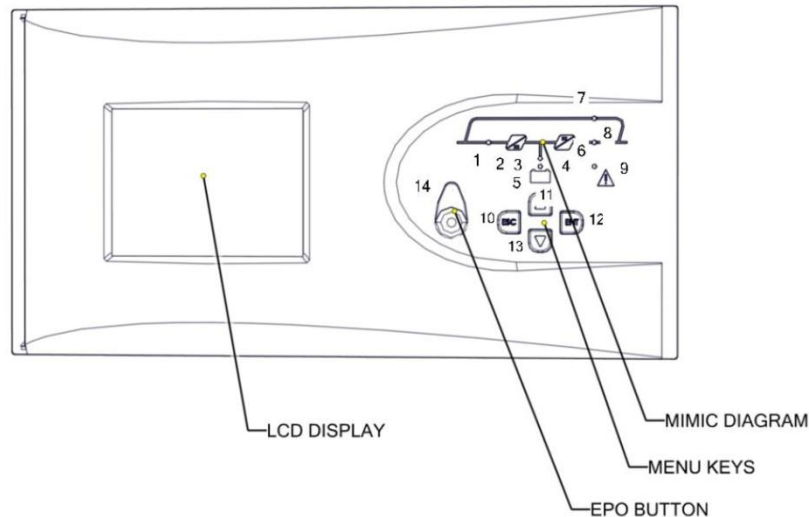

1	Rectifier indicator LED Flashes while the DC bus is ramping up. Illuminates when Rectifier works
2	AC/DC module (Rectifier)
3	Battery discharge LED Illuminates on battery mode. Flashes when UPS is started up through batteries.
4	Battery charge indicator LED Illuminates while the batteries are charging.
5	Battery module
6	DC/AC module (Inverter)
7	Static Bypass Switch LED Illuminates while the loads are fed through bypass line.
8	Inverter static switch indicator LED Illuminates when the load is fed by the inverter
9	Alarm/Warning indicator LED
10-13	Menu keys
14	EPO (Emergency Power Off) Button

Menu Flow Chart

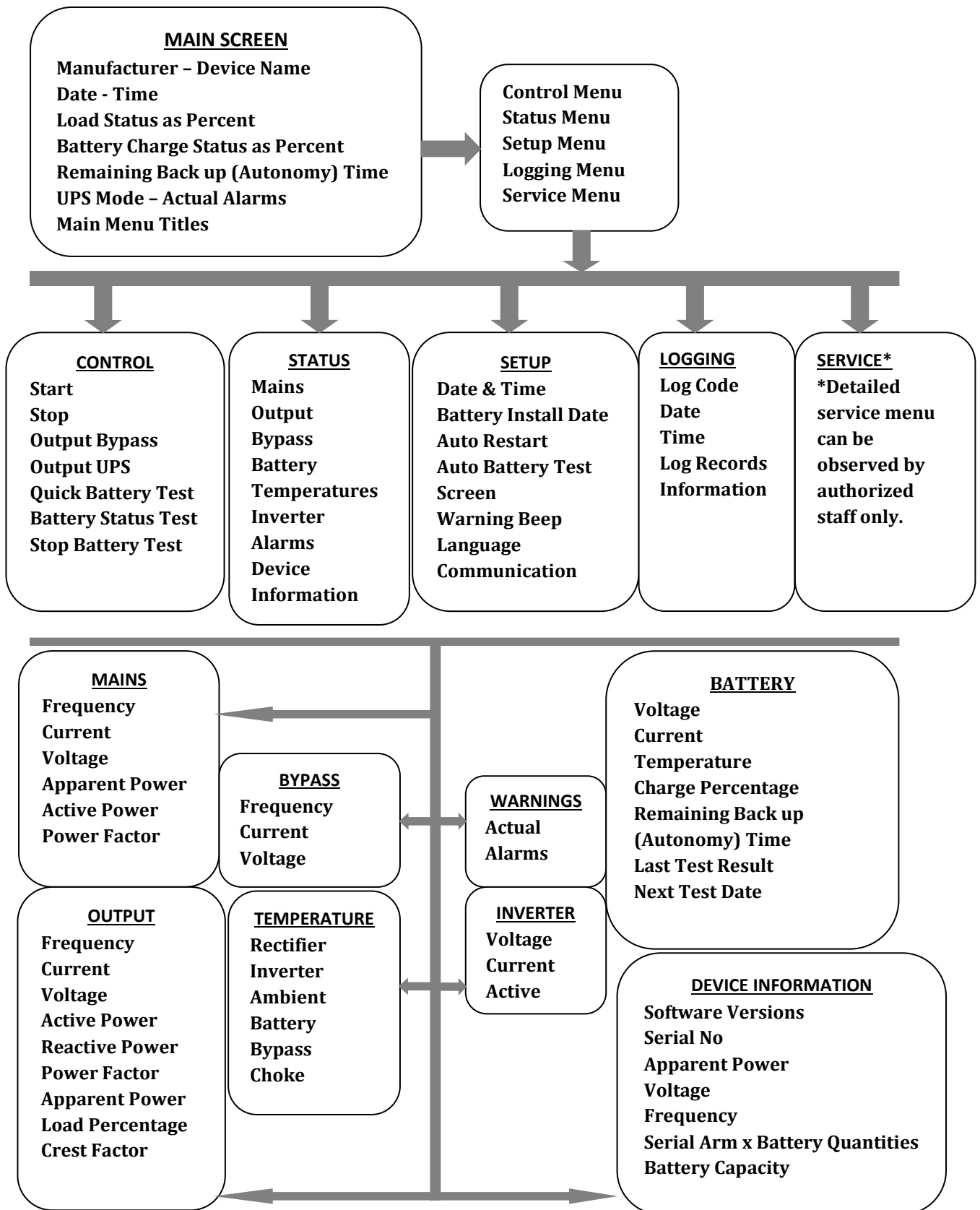

2.4.1 Opening Screen

When the front panel monitor is turned on, firstly opening screen is observed. Manufacturer – Device Name, Date – Time, Load Status as Percent, Battery Charge Status as Percent, Remaining Back up (Autonomy) Time, UPS Mode – Actual Alarms, Main Menu Titles can be observed here. In case of an alarming condition, alarms are shown on the left-down row. If no button is pressed for 5 minutes, system returns to the opening screen.

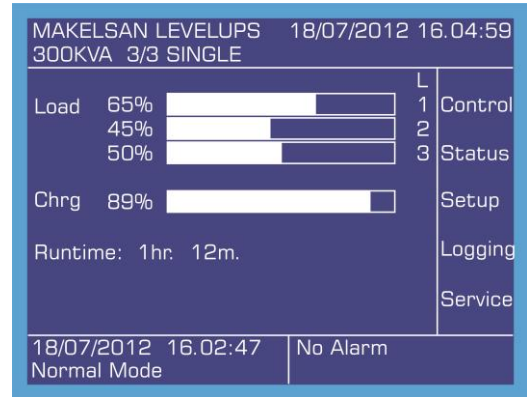

2.4.2 Main Menu Screen

To switch from opening screen to the Main menu, press Enter.



2.4.3 Navigation through the menu

Use up and down keys to move the cursor arrow. Press Enter to open a sub-menu. Press ESC to go back to the previous menu. Control sub-menu is shown below. Some sub-menus may have more than one page. Keep pressing up or down key to get to the next screen.

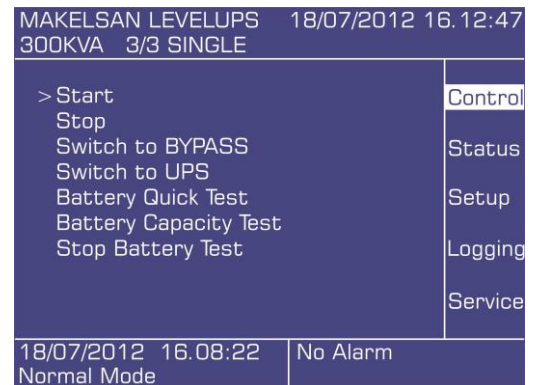

Some menus have changeable options like ON/OFF, duration or quantity. To make changes in the menu press ENTER to choose the variable, up and down keys to change the value, and press ENTER to set the new value. Press ESC to cancel.

2.4.4 Password-protected menus

Some menus such as the control menu are password protected. Press to set each digit and press ENTER to confirm.

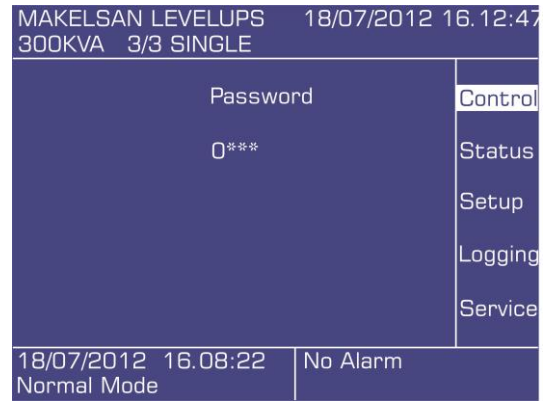

2.4.5 Control Menu

Within the control menu, you can do one of the following:

- **Start** Start the UPS
- **Stop** Stop the UPS
- **Switch to BYPASS** Switch to static BYPASS mode
- **Switch to UPS** Switch to online mode
- **Bat. Quick Test** Start the quick battery test
- **Bat. Capacity Test** Start the deep battery test
- **Stop Battery Test** Stop the battery test

Battery status test, drains the 10% of battery energy and reports batteries which has more capacity than 10% as **“Good”**, less capacity than 10% as **“Replace”** according to the test results.

After UPS is started, it makes quick battery test every 24 hours and when test counter value is zero (0).

Note: Batteries must be fully charged and kept floating for at least 1 hour before applying the quick battery tests.

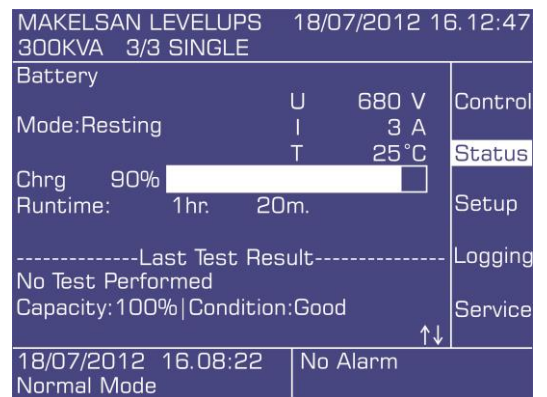

Batteries must be fully charged and kept in floating mode for at least 5 hours before performing the battery tests.

Battery tests are performed by directing the power to the mains, independently from the loads. If the mains values change during the test and are out of limits, the test will be canceled.

Status > Battery > menu timers shows the remaining time to the next test.

If **“Stop Battery Test”** command is chosen, UPS cancels the battery test and returns the previous operating mode.

2.4.6 Status Menu

On this menu you can see information about the mains, output, bypass line, battery, temperature, inverter and alarms.

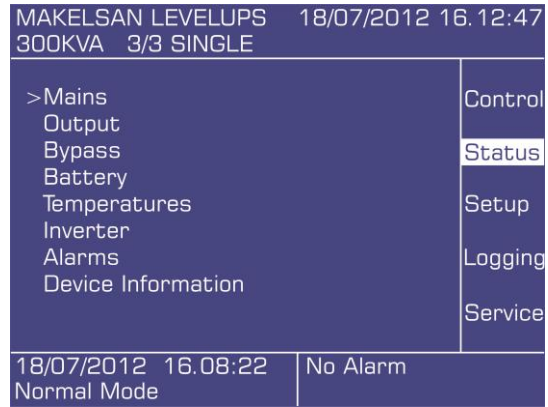

Mains

UP, I, F,UL
S, P, PF

Voltage, current and frequency of each phase (phase-neutral)
Active power, apparent power and power factor of each phase

Output

UP, I, F,UL
S, P, PF
L, CF

Voltage, current and frequency of each phase (phase-neutral)
Active power, apparent power and power factor of each phase
Load percent of each phase and crest factor

Bypass

UP, I, F

Voltage, current and frequency of each phase (phase-neutral)

Battery

Mode
U, I, °C
Charge
Autonomy Time
Last Test Result
Next Test Date

UPS operation mode
Charging voltage, current and temperature.
Charge percentage.
Remaining back-up (autonomy) time
Capacity and status according to the last test results
Next test date, time and remaining time for test

Temperature

°C,°C,°C,°C,°C

Rectifier, inverter, charger, ambient, battery and thyristor temperatures

Inverter

U, I, P

Voltage(phase-neutral), current and apparent power of each phase

Alarms

Alarms

Actual UPS alarms

Device Information

___-___-___-___

KVA, V/Hz

__x__, Ah

Inverter, rectifier, CPLD, front panel software version
UPS serial no
Apparent power, instantaneous output voltage (phase-neutral),
instantaneous output frequency
Parallel battery arm number x Serial battery arm number Battery
capacity adjusted in UPS

2.4.7 Setup Menu

Setup menu consists of the following:

Date & Time

To set date and time, use up and down keys to choose the variable you want to set and press Enter.

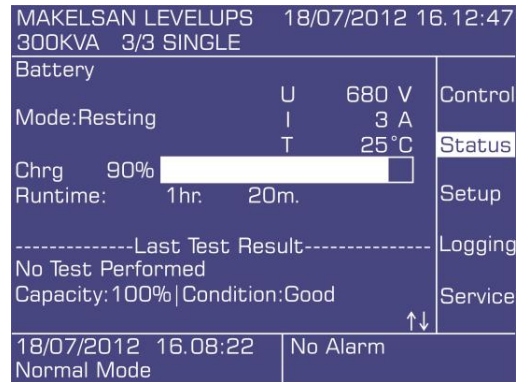

Then use up and down keys to set the value, and press Enter



Battery install date

Use this menu to set the battery install date, only when new batteries are installed.

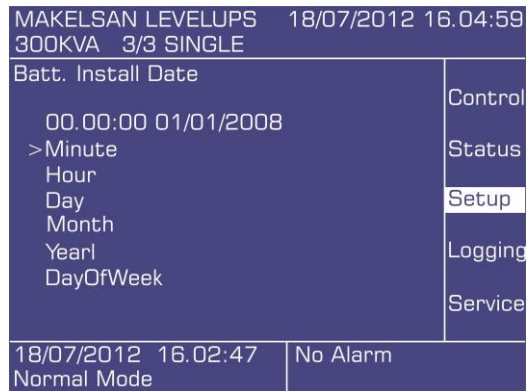

Auto restart

In battery mode, the device turns off at the end of battery discharge. Auto-restart can be used to restart the UPS automatically when the mains are restored.

Turn on auto-restart and set the time to define when the device will be started after the normal values of the mains are restored.

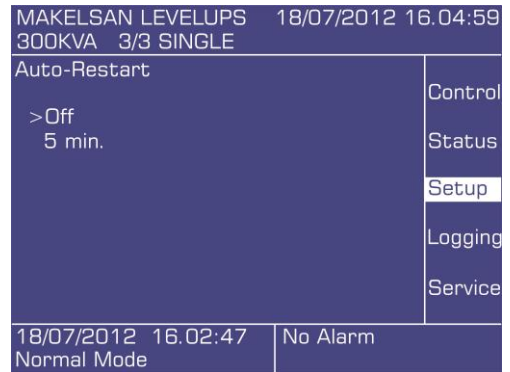

Battery self test

This function can be turned on to start the user independent battery tests.

Set the time interval for the next test.

Note: Battery self test is the equivalent of battery quick test.

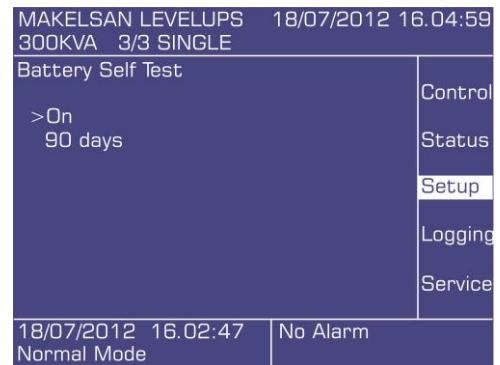

Screen

Change the screen contrast to make it more visible on different environmental conditions.

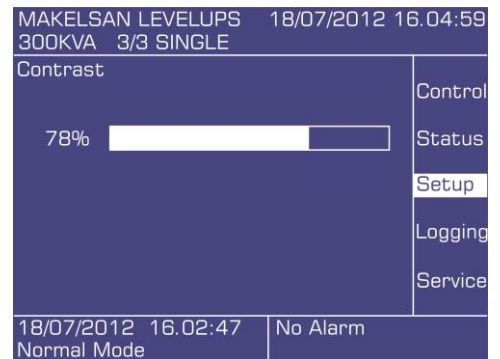

Beeper

Turn the beeper sound on/off.

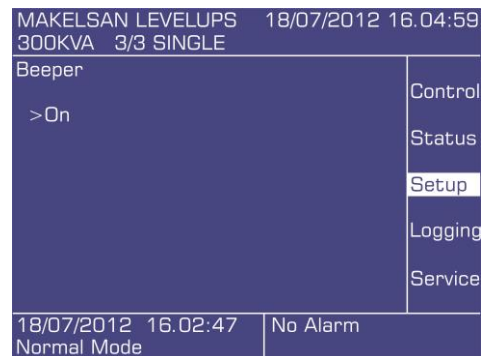

Language

Set the menu language.

MAKELSAN LEVELUPS 18/07/2012 16.04:59	
300KVA 3/3 SINGLE	
Language	Control
>English	Status
	Setup
	Logging
	Service
18/07/2012 16.02:47	No Alarm
Normal Mode	

Communication

Set the protocol for the RS232 connection.

The options are SEC and TELNET

MAKELSAN LEVELUPS 18/07/2012 16.04:59	
300KVA 3/3 SINGLE	
Communication	Control
>SEC	Status
	Setup
	Logging
	Service
18/07/2012 16.02:47	No Alarm
Normal Mode	

2.4.8 Logging Menu

Last 500 events of the device can be seen in the logging menu.

MAKELSAN LEVELUPS 18/07/2012 16.22:47	
300KVA 3/3 SINGLE	
18/07/2012 16.15:18 E001 <-----	Control
Batteries Changed	Status
18/07/2012 16.08:22 E002	Setup
Ambient Abnor. Temp.	Logging
18/07/2012 16.08:22 E003	Service
EPO key pressed	
18/07/2012 16.15:18	No Alarm
Normal Mode	

When viewing a log, press enter to see detailed info about the UPS. All recorded data for that particular event (status, setup etc.) can be seen on the menu. Use up and down keys to see older/newer event logs.

MAKELSAN LEVELUPS 25/07/2012 13.03:20		
300KVA 3/3 SINGLE		
25/07/2012 11.13:51 E004 <-----	Control	
Normal Load	Status	
25/07/2012 10.50:50 E005	Setup	
Over Load	Logging	
25/07/2012 10.49:02 E006	Service	
Bypass Mode		
25/07/2012 11.14:34	No Alarm	
Normal Mode		

2.4.8 Service Menu

Service menu is password protected, and cannot be accessed with the user password.

MAKELSAN LEVELUPS 18/07/2012 16.12:47		
300KVA 3/3 SINGLE		
Password	Control	
0***	Status	
	Setup	
	Logging	
	Service	
18/07/2012 16.08:22	Alarms	
Normal Mode		

3 INSTALLATION

3.1 Single Module Installation

This section contains the warnings and control actions that must be performed before the UPS start-up. Additionally, you will find here important information about the UPS cabins transportation, positioning and connections.

3.1.1 Warnings



THE UPS MUST BE INSTALLED BY A CERTIFIED ELECTRICIAN OF MAKELSAN. THE WARRANTY IS VALID ONLY FOR THE UPS INSTALLED BY A CERTIFIED ELECTRICIAN OF MAKELSAN.



BATTERY HAZARD

Battery terminal voltage reaches up to 450 Vdc during operation.

Proper safety gear must be used to protect the skin and the eyes from electrical arcs.

Check the batteries for leakage before using them.

ESD-protected rubber gloves should be used.

Batteries with leakage must never be used and must be replaced. Defected batteries must be uninstalled and transported to the destruction points with safety precautions taken.

Battery ingredients are hazardous. In case of contact with battery ingredients, rinse the skin with water, and consult a physician if irritation occurs.

Remove any metal accessories (ring, watch, etc.) before working on the device.

UPS needs three phase and four cable (+ground) supply system for input. This supply system type is confirmed as IEC60364-3 standards. Optionally UPS have transformers which have ability to convert from 3 cables to 4 cable system. If IT AC power distribution system will be installed, 4 pole-circuit breaker systems must be used. More detailed explanations can be found in the IEC60364-3 standards titles.

3.1.2 Pre-installation check up

Before installation of the device the following control actions must be taken, these first and most important steps will secure the accurate operation of the product.

- Check if any damage was done to the device during transportation. Report any damages instantly.
- Make sure that model power rating is right. Check the device label for the actual power rating.

3.1.3 Positioning

The device and the batteries are designed for the indoor use. Keep the device in a cool and dry place, with the air flow, humidity and temperature values must be within the specified range.

3.1.3.1 Positioning The UPS

In the LevelUps 300 - 400 - 500 KVA Series, fresh air enters the device from the front and behind. Goes out from the fans on the rear side of the device. Care must be taken in order not to cover the air entrance and exit spots. UPS must be positioned on a place where it is protected from water etc. contact risks.

If the area is dusty, optional filters must be used for such environment. These filters usage must be done as per instructions document.

Below given cooling values must be provided to reach the maximum level of performance of UPS and batteries

UPS	Amount of BTU /h for cooling	Bridge Load 100% (Non-linear) estimated BTU / h value for load working
300KVA (PF1)	51200	61500
300KVA (PF0,9)	46100	55320
400KVA (PF1)	68300	82000
400KVA (PF0,9)	61500	73800
500KVA (PF1)	85400	102500
500KVA (PF0,9)	76800	92200

* The values must be selected under normal conditions. A cooling system was added over 10-20 % of it is recommended to be selected

3.1.3.2 External Battery Configuration

Batteries should be used in the environment with uniform temperature conditions. Temperature is a major factor in determining the battery life and capacity. The operating temperature for batteries recommended by battery manufacturers is 20-25 °C. Operating above this range will reduce the battery life while operation below this range will reduce the battery capacity, as a result the expected backup time might not be obtained while autonomy. Please keep batteries away from heat sources and main air inlets. Pay attention and observe the following points.

- Keep batteries away from main heat sources.
- Keep batteries away from main air inlets.
- Keep batteries away from the humid places. Hereby batteries can be prevented from terminal oxidations and possible leakage currents.
- Please use aR or gR semi-conductor type fuse at the battery rooms and cabinets.
- If it is possible , please use breaker switch without fuse for the battery cabinet.
- Keep battery cabinets and shelves high above the ground. UPS should be protected against floods or liquid contacts.
- Battery rooms should be properly ventilated.
- Shelves will be accessible in touch if batteries are in battery room. Therefore please keep restricted accessing to battery room. Use necessary safety writings and strips

Especially, for the external cabinet batteries system of UPS, fuses must definitely be used. These fuses must be mounted as close as possible to the batteries. This closeness will increase the electrical operation safety.

THE TABLE OF LEVELUPS SERIES EXTERNAL BATTERY USAGE						
Device Rating (KVA)	300 (PF1)	300 (PF0,9)	400 (PF1)	400 (PF0,9)	500 (PF1)	500 (PF0,9)
Batteries in series	30	30	30	30	30	30
Number of Paral. arms	2	2	2	2	2	2
Total number of Batt.	60	60	60	60	60	60
Maximum battery voltage at the charging current. (A)	45,30	40,7	60,4	54,3	75,5	67,9
The maximum charging current of cutting current. (A)	512,0	460,8	628,7	614,4	853,4	768,0
Recommended internal fuse (A)	800	630	800	1000	1500	1250

External battery cabinet and battery room applications are given below as an example. The application form may vary according to the customer.

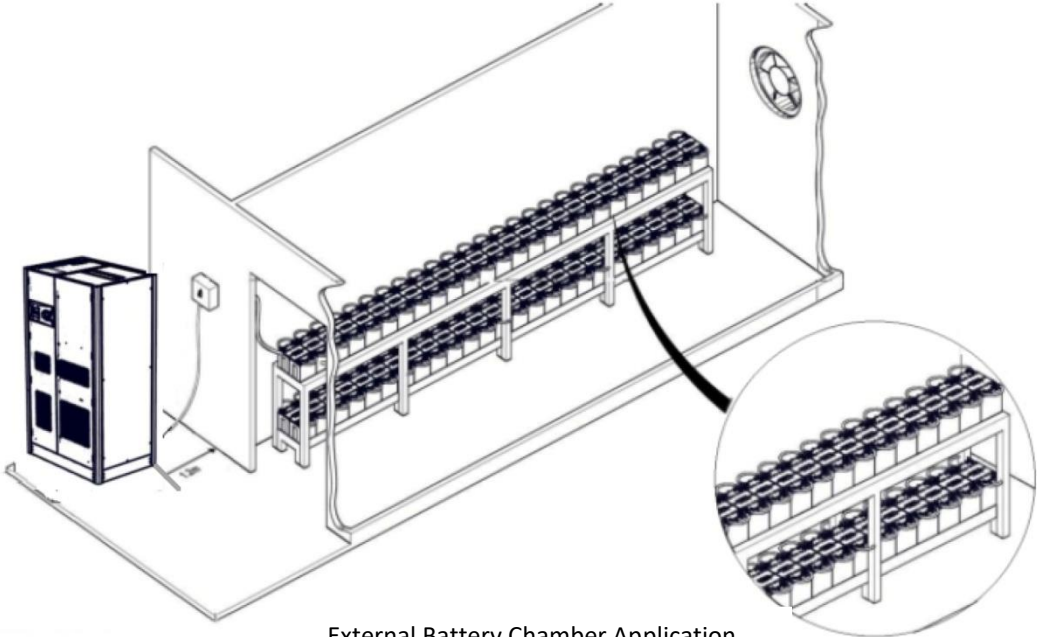

External Battery Chamber Application

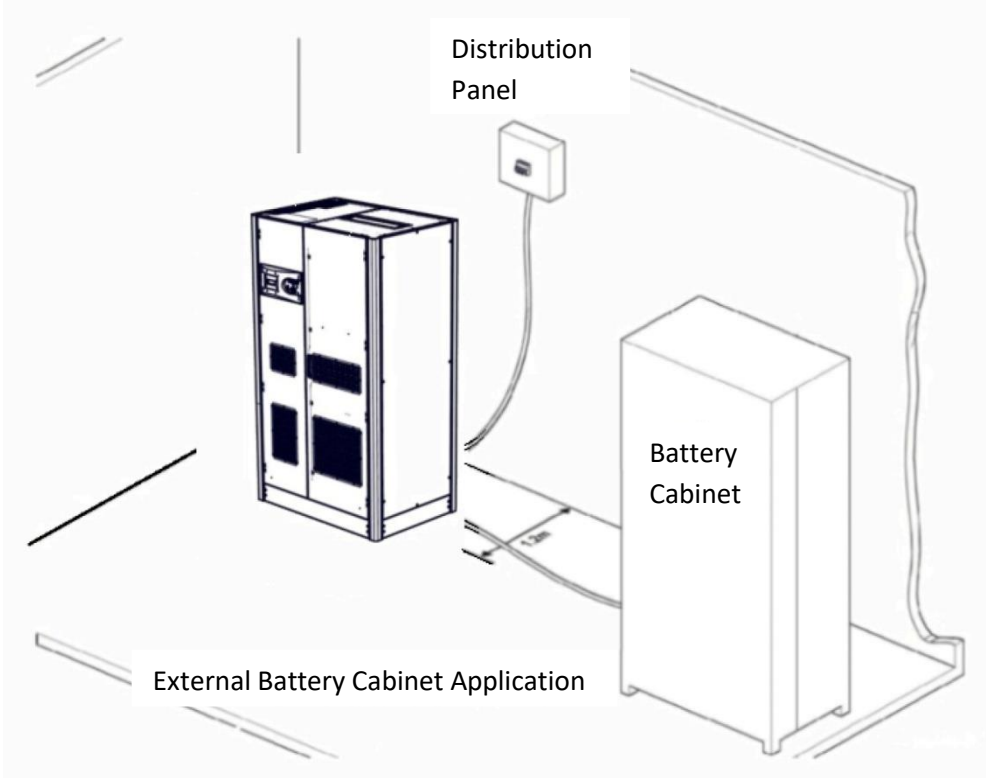

External Battery Cabinet Application

3.1.4 Transportation Type of Cabinets

Carrying vehicles or handling accessories must have enough features and characteristics to carry UPS's weight.

The front side wheels of UPS must be locked after positioning properly. The back side wheels are fixed. Be more careful of sudden movements, especially when batteries are inside of cabinet.

Move the UPS as rarely as possible.

3.1.5 Mains, Load and Battery Connections

Makelsan strictly recommends a distribution board for the UPS outputs. Proper fuses and breakers must be used in such distribution board. A-B type fuses or magnetic breakers are recommended if the load is suitable.

3.1.5.1 External Protection

To protect the AC inputs, thermal magnetic breakers or V type breakers must be installed on the distribution board.

Over current protecting must be installed on mains input distribution board and fuses must be chosen 135% higher rated than the ones given in the table below. Fuses must be C-type.

Ground leakages flow to the ground through the EMI filters on the input and the output of the UPS. Makelsan recommends the use of 300mA rated relays for handling leakage currents.

Those relays must also be:

- ✓ Resistant to both positive and negative DC pulses,
- ✓ And not sensitive to transient currents.
- ✓ Must be sensitive to currents which is average between 0,3-1 A.

3.1.5.2 Cabling and fuse configuration

Full load input and output currents must be reviewed for proper cabling and fuse selection.

UPS Rating (KVA)	Rated Currents (A)					
	Input Currents (3P+N)			Output Currents (3P+N)		
	380V	400V	415V	380V	400V	415V
300KVA (PF1)	633,2	605,7	580,5	454,5	434,8	416,7
300KVA (PF0,9)	569,9	565,1	522,5	454,5	434,8	416,7
400KVA (PF1)	844,3	807,6	774,0	606,1	579,7	555,5
400KVA (PF0,9)	759,9	726,9	696,6	606,1	579,7	555,5
500KVA (PF1)	1055,5	1009,5	967,5	757,6	724,6	694,4
500KVA (PF0,9)	949,9	908,6	870,7	757,6	724,6	694,4

Note: The table is calculated by taking the minimum input voltage and the maximum battery charge current.

It should be noted that with non-linear loads, neutral current may rise up to 1.5 times the phase current.

Ground cable must be connected directly to ground line and must be kept as short as possible. Typical ground cable cross sections are 150 mm² for 300 kVA, 190 mm² for 400 kVA and 240 mm² 500 kVA ratings. The length of the cable must not be over 5 meters.

3.1.5.3 Cable connections

All electrical connections of the UPS are made from the front side of the device.



3 POLE-CIRCUIT BREAKERS (SWITCH) ARE USED FOR THE INPUT AND OUTPUT OF UPS, NEUTRAL LINE MUST NOT BE INTERRUPTED.



INPUT AND BYPASS NEUTRAL IN LINE EQUIPMENT IS UNITE. INDEPENDENT READING IS SO HIGH LINE POTENTIAL THROUGH OF NEUTRAL SHOULD BINDING INSTRUMENT.

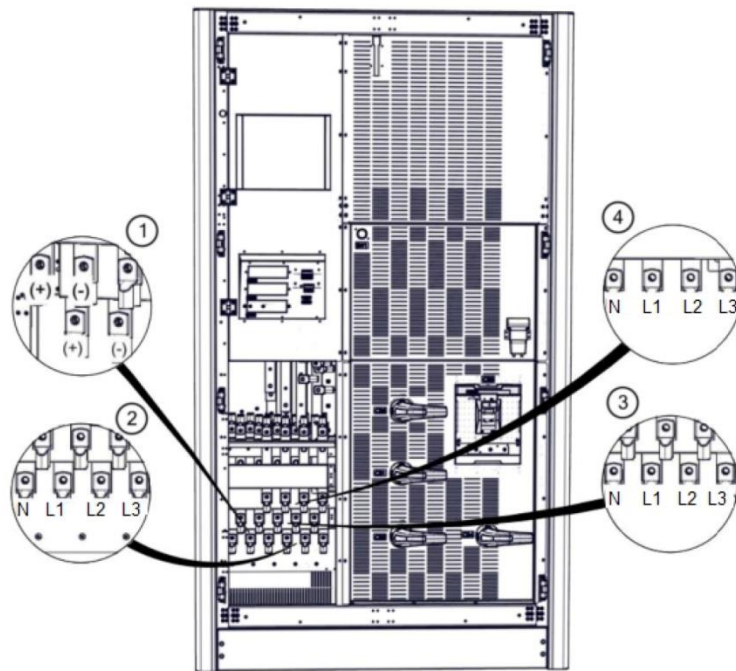

1	Battery Terminals
2	Output Terminals
3	Input Terminals
4	By -Pass Terminals

1. Turn **OFF** all the distribution board breakers (both input and output distribution boards) to make sure that the load and mains are completely disconnected from any cable.

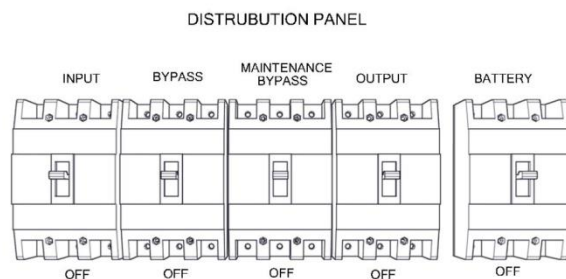

2. Connect the ground cable. Unscrew and remove the metal board on the rear side of the device.

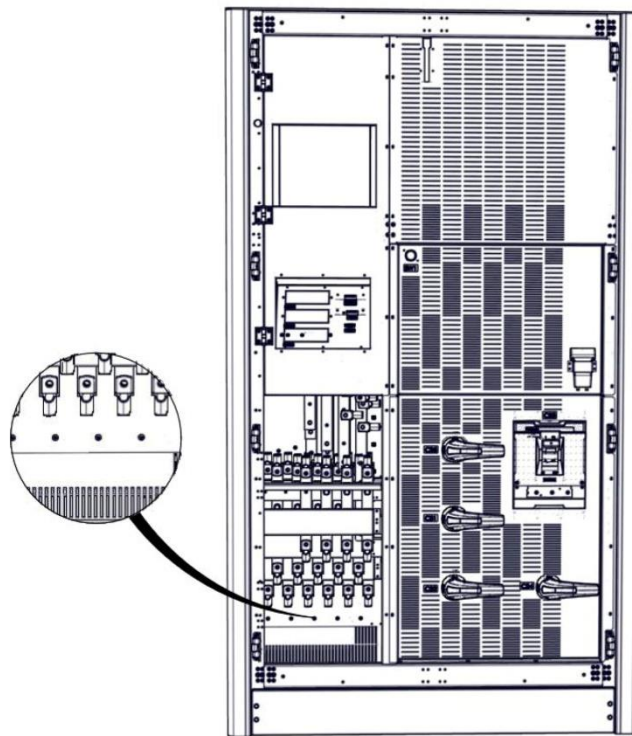

3. Make sure that the circuit breakers are off. The use of these circuit breakers is explained on the operation section.

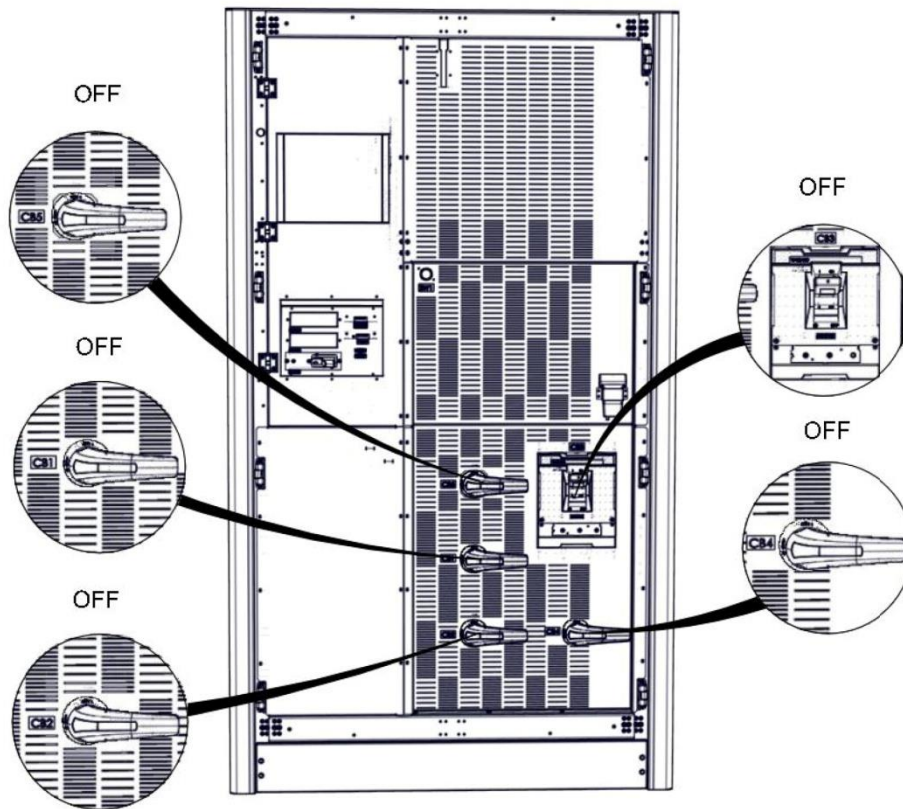

4. Connect the input cables.

- R to INPUT L1,
- S to INPUT L2,
- T to INPUT L3,
- N (Neutral) to INPUT N.

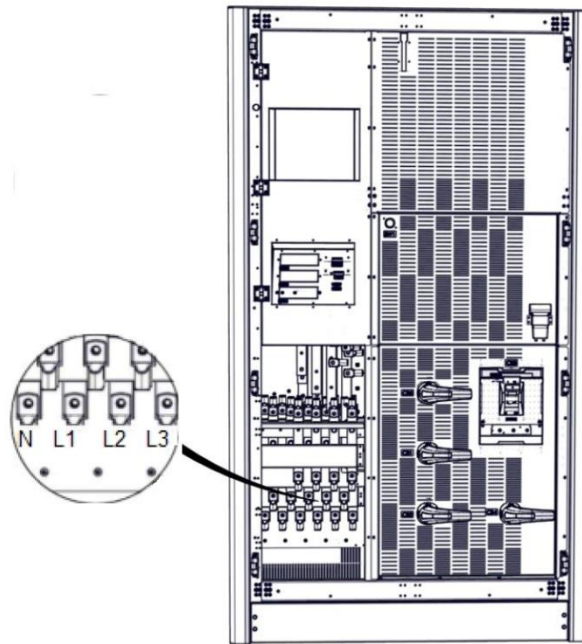

5. Check the phase sequence.
6. Repeat steps 4-5 for output cables.
7. Replace the rear board and tighten the screws

Use the cable clips to stabilize the cables when the connections are done.



MAKE SURE THAT THE LOADS ARE ISOLATED FROM THE UPS OUTPUT IF THEY ARE NOT READY TO BE CONNECTED.



MAKE SURE THAT THE CABLES ARE CONNECTED PROPERLY BEFORE UPS IS STARTED. ADDITIONALLY, CHECK IF THERE IS GALVANIC ISOLATION TRANSFORMERS AT INPUT OF UPS AND CONSIDER THE LOCAL DIRECTIONS.



CHECK THE GROUNDING BEFORE STARTING THE UPS. WRONG WORKS OR GROUNDING ON UPS OR OTHER DEVICES OF INSTALLATION MAY BE HAZARDOUS. WRONG WORKS AND GROUNDING MAY DAMAGE UPS AND ANOTHER SYSTEM ON THE INSTALLATION.

3.1.5.4 Battery connections

You can find explanations about installation procedures and connections of internal and external batteries in this section.

3.1.5.4.1 External Battery Installation Procedure and Connection

You can find details about how to configure external batteries above under “External Batteries Configuration” title.

The information about connection of external batteries and UPS is given in this section.



AVOID SHORT CIRCUITING BATTERIES . SHORT CIRCUIT THE BATTERIES CAN DAMAGE YOU AND YOUR ENVIRONMENT!

BATTERY TERMINAL MAY RISE UP TO 450 VDC!

1. Switch "CB4" breaker OFF on UPS.
2. If there is breaker on battery cabinet, Switch it "OFF".
3. Remove the fuse on battery cabinet.
4. Remove battery fuse on UPS.

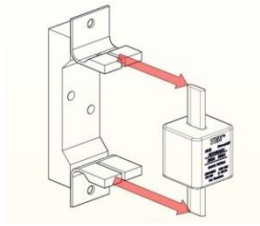

5. Make sure of serial and parallel connections of external battery packs are correct.
6. Connect the cable to terminals of two neutral "N (battery neutral)" , one "+Battery" and one "- Battery" respectively.
7. Connect four cables that come from UPS to terminals on battery cabinet or in battery room according to external battery connection diagram below. As follows:

- | | | |
|---------------|---------|-------------------------------------|
| ➤ N(UPS) | ←-----→ | Positive Battery Group "-" terminal |
| ➤ N(UPS) | ←-----→ | Negative Battery Group "+" terminal |
| ➤ "+ BATTERY" | ←-----→ | Positive Battery Group "+" Terminal |
| ➤ "- BATTERY" | ←-----→ | Negative Battery Group "-" Terminal |

8. Make sure that the polarities are connected correctly by checking battery connections for the last time.

9. Replace battery fuse on UPS.

10. Replace battery fuse on battery cabinet.

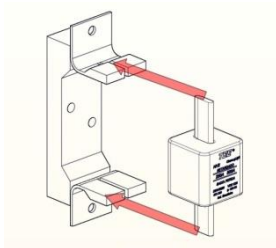

11. If there is breaker on battery cabinet, switch it "ON".

12. Check if there is appropriate battery voltages to the battery input terminals by proper measuring device.

External battery cable selection is determined by application. Fuses which are recommended for UPS and battery cabinet are given. To connect to these type fuses, the lowest diameter cables are suggested. Please, refer to standard called EN 50525-2-31(VDE 0100-430) in this subject. The selection should be such that the cable will allow at most 0.5 Vdc decreasing.

"External Battery Temperature Measurement Kit" is used for optimization according to battery temperatures, batteries use is optimized according to temperature.

The external battery connection diagram is given below.

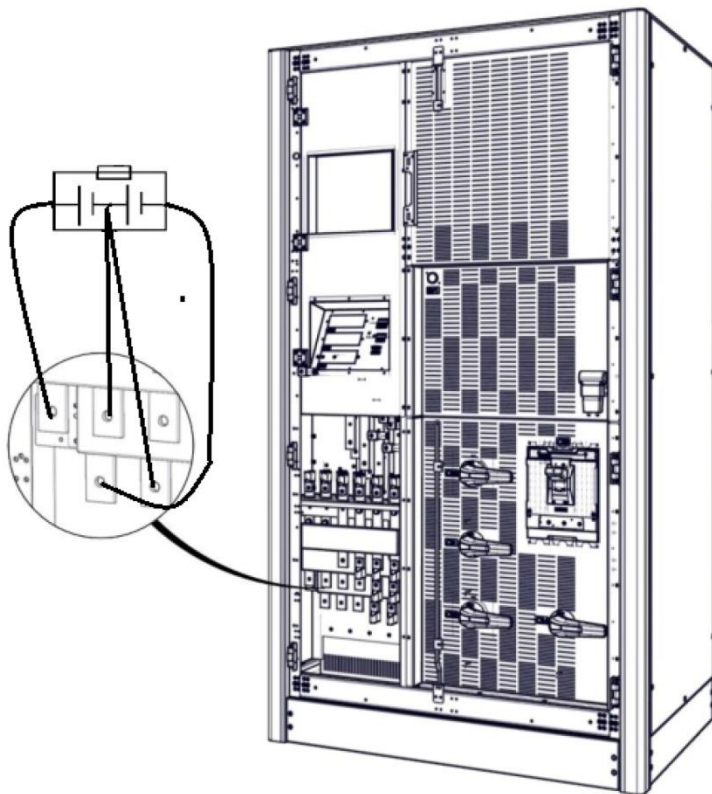

3.1.5.5 Control and Communication Cable Connections

MAKELSAN UPS have standard or optional connections of advanced external battery cabinet, environmental monitoring, control panels and various intelligent monitoring.

Connections on the front side of UPS:

- One RS232 serial communication connection (Standard),
- Two expansion slots (Optional)

Connections on the top side of UPS:

- One parallel port (Standard)

3.2 Parallel Installation

The product which you have bought can be operated in parallel; however, this feature is offered as an option. Please contact your dealer for parallel operation.



PARALLEL APPLICATION SHOULD BE MADE BY AUTHORIZED PERSONAL OF MAKELSAN !

In case of need for redundancy or more power, LevelUps series can be operated in parallel up to quantity 8 (eight). A schematic diagram which shows two UPS connected in parallel can be seen below.

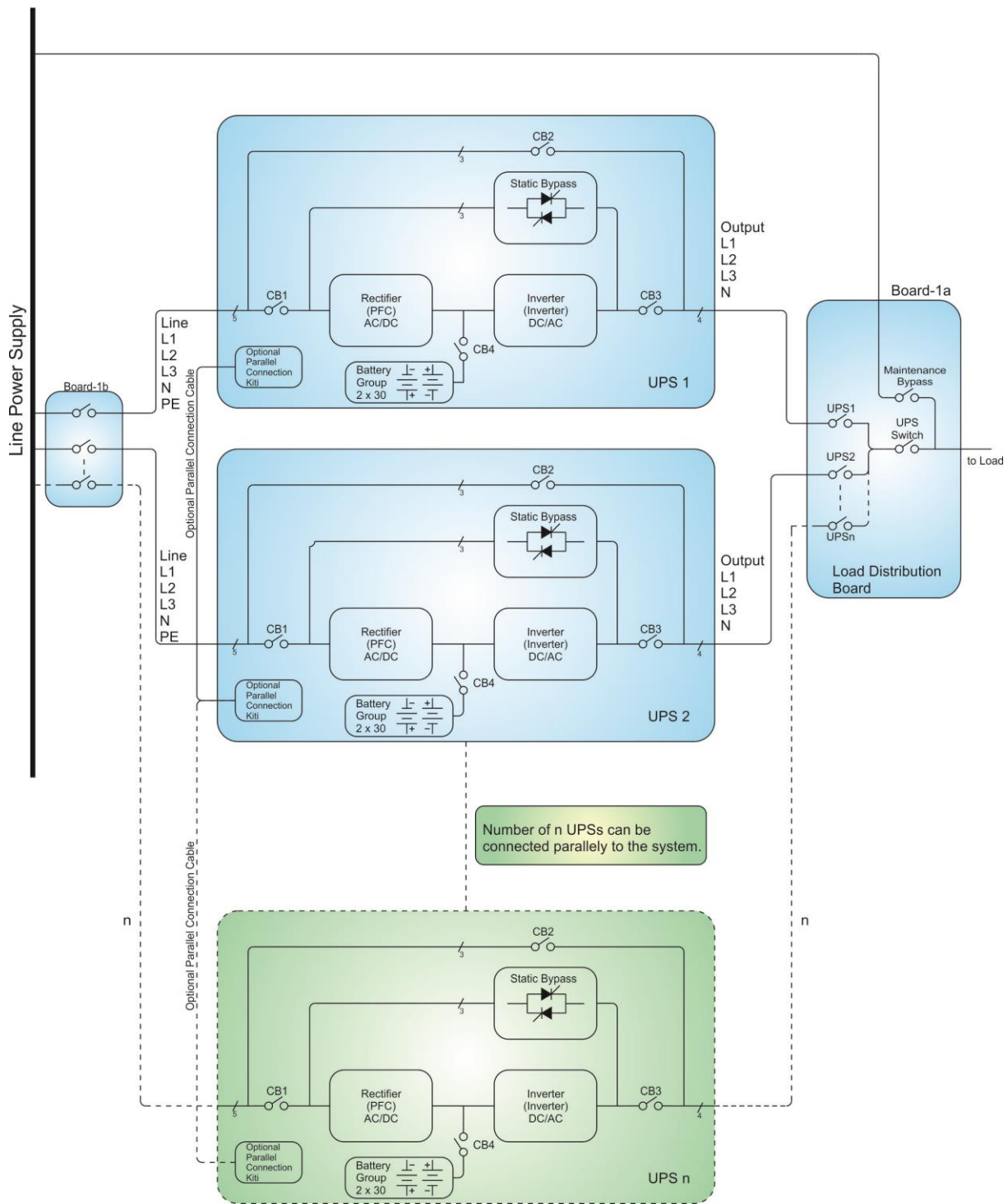

Input and output of more than one UPS are connected to each other; but definitely each battery group is different from another, batteries cannot be used in common. The following points should be considered while placement of UPS in parallel system and their electrical connections are made:

- The UPSs which are connected in parallel must be from the same series and must have the same rated power.
- Devices must be running on the same firmware, if not, old firmware must be updated.
- Devices must be located as close possible as to each other (max. 6 x 110 cm paralleling cables.)

- Each device must have its own ground cable.
- UPS must be connected in parallel on the distribution panel and phases must be connected correctly. (U1-U2-...-UN), (V1-V2-...-VN), (W1-W2-...-WN).
- Each UPS must have their own battery set, batteries cannot be used for more than one device at the same time.
- Power input and output cables from the device to the distribution board must be equal in length and cross section in order to proceed equal current sharing.

3.2.1 Parallel Settings

Connect the parallel cable as shown in figure below. Only use the cables provided by Makelsan.

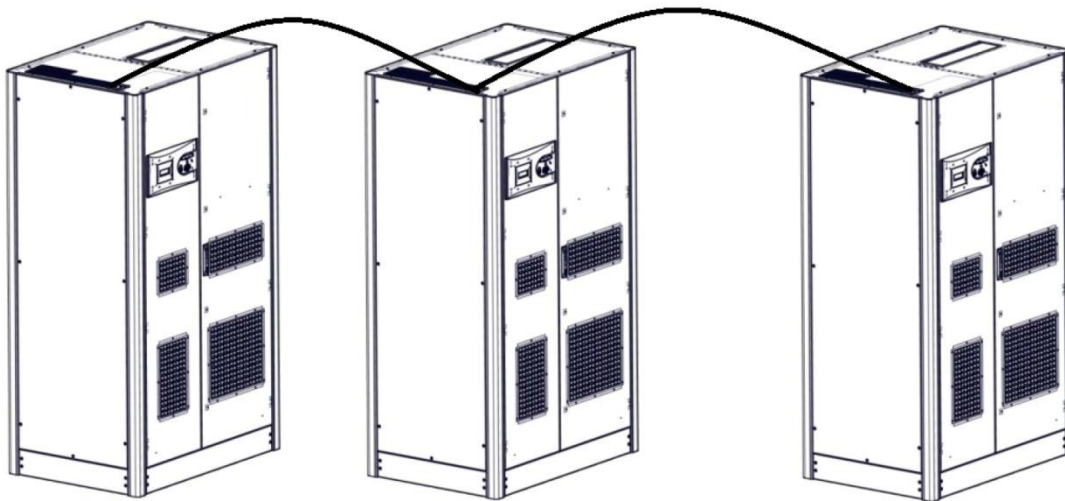

Parallel Connection Socket

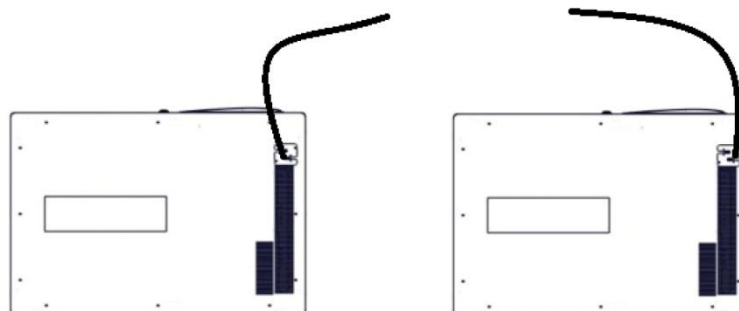

Software settings on the user panel should be made by authorized personnel.

4 OPERATION

4.1 Operation Procedure

You can find information about circuit breaker, first start-up , types of UPS operation tests , turning UPS off , EPO and RS232 serial communication system in this section.

4.1.1 Circuit Breakers

There are four circuit breakers on the behind side of the device. These are used for the AC input, maintenance bypass, output and the battery connections respectively.

Three-phase AC voltage is applied through **CB1** to input of UPS.

AC input voltage will be applied directly to loads through **CB2**. In this way, maintenance purposed switching is done properly. If UPS is actived while it is working thanks to auxiliary short circuit info located in **CB2**, mains makes the bypass static switches actived. The system will be switched to maintenance mode smoothly.



CB3, AC STATIC BYPASS LINE VOLTAGE USED TO APPLY.

External batteries are connected to UPS through **CB4**.

CB5 is used as an external bypass switch.

Active Breakers	Operation Mode	Explanation
CB1, CB3, CB4.CB5	Normal Mode	UPS operates in normal mode.
CB1, CB3, CB4,CB5	Static Bypass Mode	UPS is overloaded, loads will be transferred to static bypass line temporarily.
CB2	Maintenance Mode	UPS is shut down for maintenance, loads will be fed through mechanical bypass line.

4.1.2 First start-up



WAIT FOR AT LEAST 5 SECONDS BETWEEN EACH STEP.

1. Turn all circuit breakers OFF.
2. Push the soft start button (SW1) at least for 10 sec.
3. Turn input circuit breaker (CB1) ON. If there is an external bypass input, put the external bypass switch (CB5) to position closed circuit (ON)

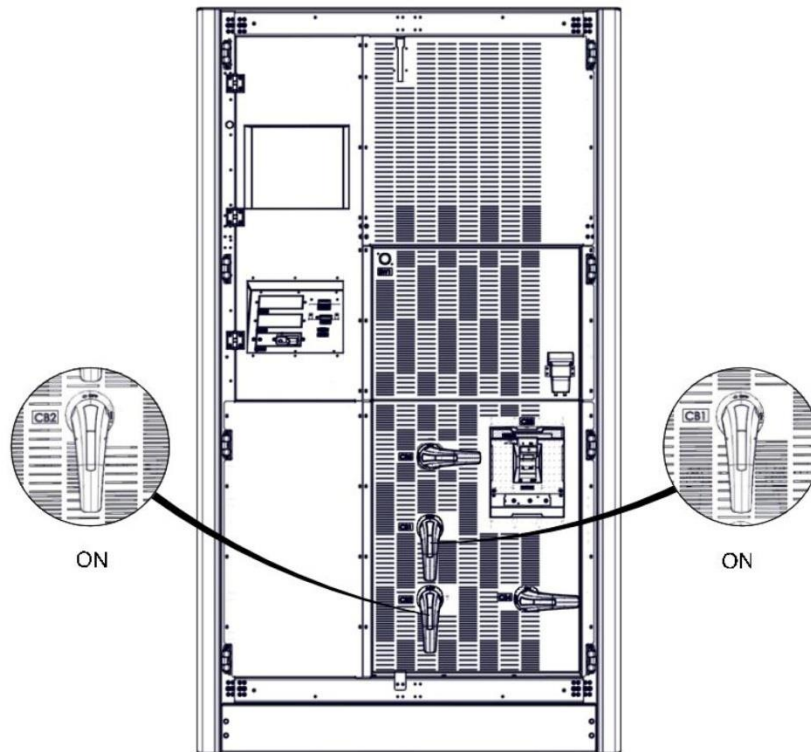

4. Start the UPS using the front panel.

Main menu > Control > Password > Start

MAKELSAN LEVELUPS 18/07/2012 16.12:47	
300KVA 3/3 SINGLE	
> Start	Control
Stop	
Switch to BYPASS	Status
Switch to UPS	
Battery Quick Test	Setup
Battery Capacity Test	
Stop Battery Test	Logging
	Service
18/07/2012 16.08:22	No Alarm
Normal Mode	

5. Check the UPS has switched to normal operation mode, via mimic diagram LEDs and LCD panel.

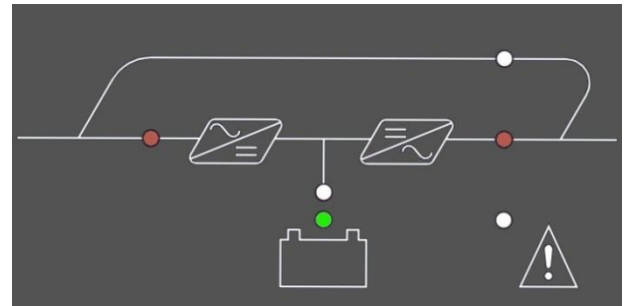
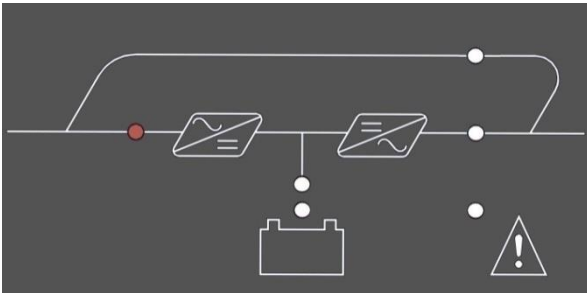

6. Turn battery circuit braker (CB4) ON.

7. Turn output circuit braker (CB3) ON.

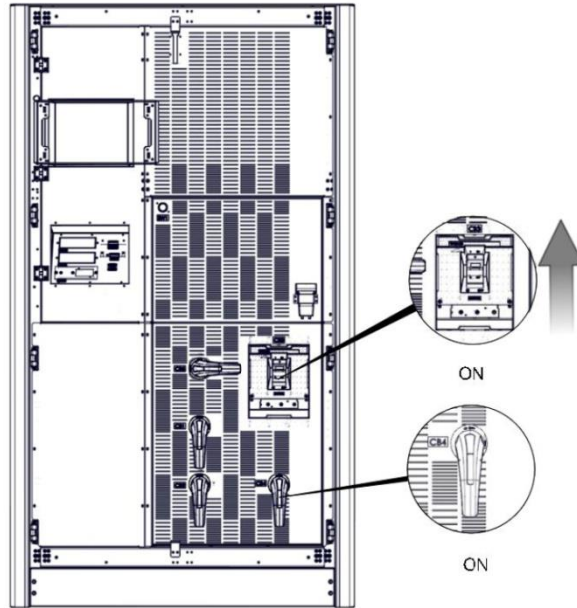

8. The loads which are connected to UPS can be turned on.

After all these steps, check that load is fed through inverter static switches via mimic diagram. In a contrary situation, check UPS total and phase loads. The UPS gives audio alerts in an overload condition, without feeding critical AC loads.

4.1.3 UPS Operation Modes Testing

After first start-up check device operation by switching between the operation modes manually.

4.1.3.1 Switching from Online Mode to Battery Mode

Turn CB1 OFF. This action cuts off the mains voltage and the UPS starts operating on battery mode. Turn CB1 back ON again if everything is ok.

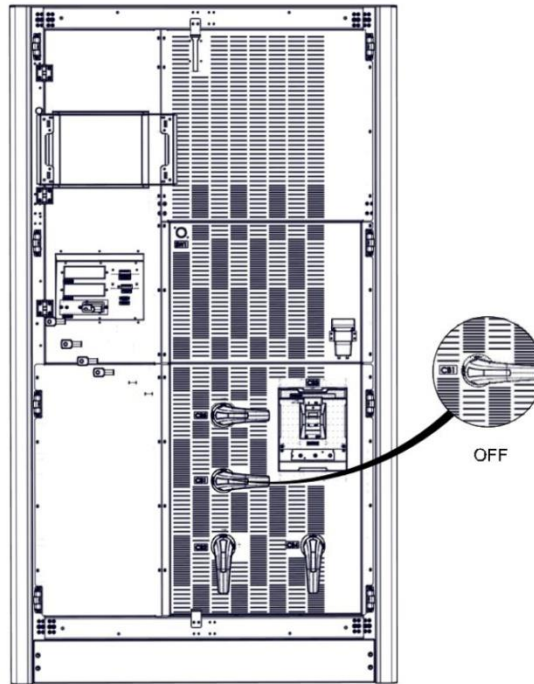

4.1.3.2 Switching from Online Mode to Static Bypass Mode

Use the front panel to switch the device to static bypass mode. The panel is active in the following order following the bypass mode.

Main menu> Control > Switch to Bypass

MAKELSAN LEVELUPS 18/07/2012 16.12:47	
300KVA 3/3 SINGLE	
Start	Control
Stop	
> Switch to BYPASS	Status
Switch to UPS	
Battery Quick Test	Setup
Battery Capacity Test	
Stop Battery Test	Logging
	Service
18/07/2012 16.08:22	No Alarm
Normal Mode	

Check the mimic panel to make sure that the device has switched to bypass mode. In this case, the product was transferred to static bypass mode. Loads received from the network is supplied with voltage.

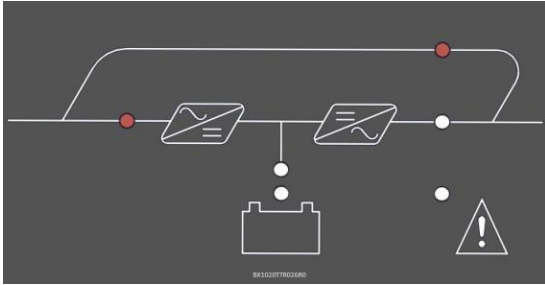

NOTE: UPS will not switch to bypass mode if the inverter voltage is out of limits or there is an overload or over temperature situation.

4.1.3.3 Switching from Static Bypass Mode to Online

Use the front panel to switch the device to online mode. Check the mimic panel to make sure that the device has switched to online mode.

Main menu > Control > Switch to UPS

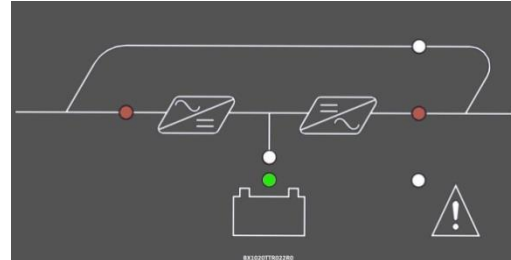
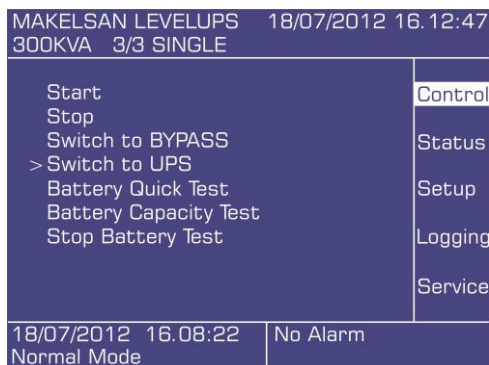

NOTE: the UPS will not switch to normal mode if the inverter voltage is out of limits, or there is an over load or over temperature situation.

4.1.3.4 Switching from Online Mode to Maintenance Bypass Mode



WARNING: MAKE SURE THAT THE INVERTER OUTPUT IS SYNCHRONOUS WITH THE MAINTENANCE BYPASS LINE BEFORE SWITCHING TO MAINTENANCE BYPASS MODE. OTHERWISE THERE IS A POSSIBILITY OF CUTTING OFF THE LOAD POWER FOR A SHORT WHILE.



USE THE FRONT PANEL TO SWITCH THE DEVICE TO STATIC BYPASS MODE. CHECK THE MIMIC PANEL TO MAKE SURE THAT THE DEVICE HAS SWITCHED TO BYPASS MODE.

Main menu > Control > Switch to Bypass

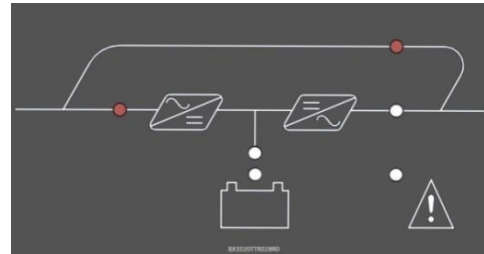
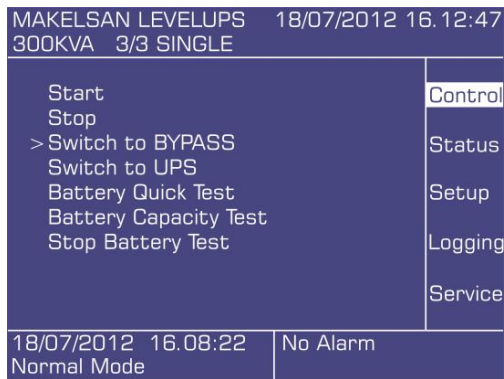

1. Turn CB2 ON.

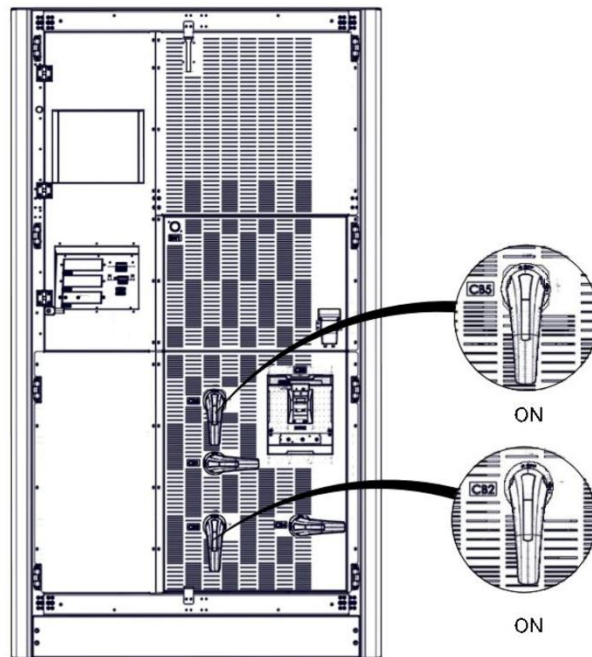

2. Stop the UPS using the user front panel.

Main menu > Control > Stop

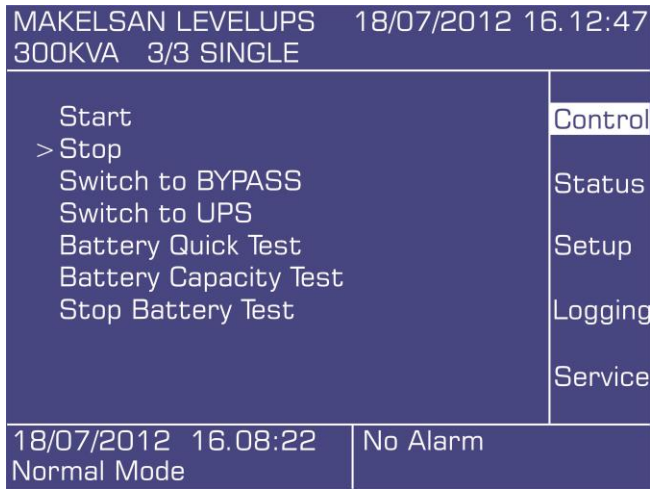

3. Turn CB1,CB5, CB3 and CB4 **OFF**.

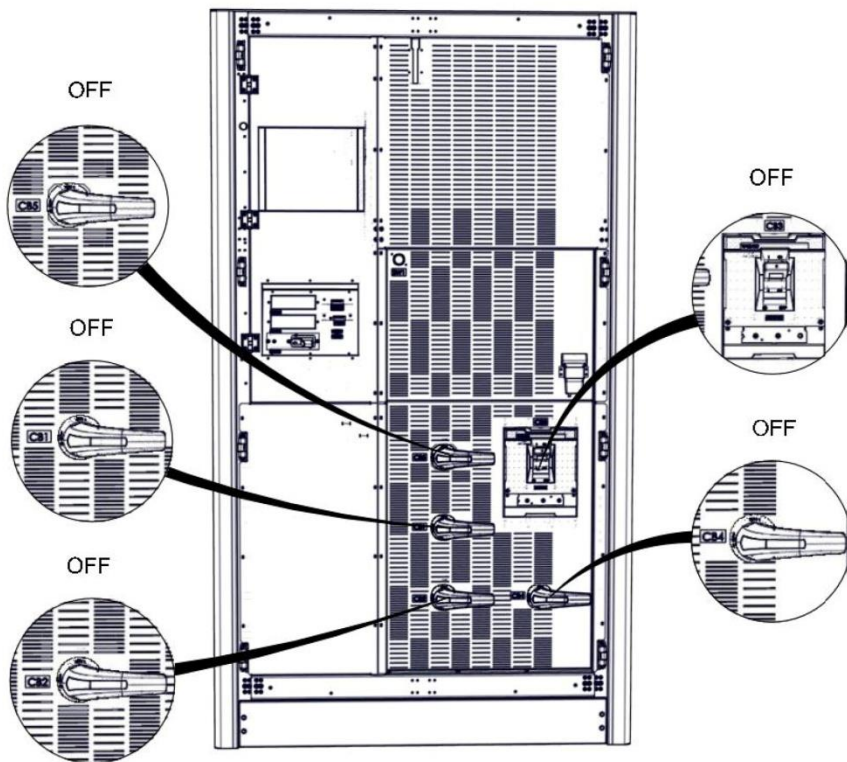

WARNING:

THE UPS MUST BE DISCONNECTED FROM THE MAINS AND BATTERIES BEFORE SERVICING. ALSO WAIT FOR AT LEAST 5 MINUTES FOR THE DC BUS CAPACITORS TO DISCHARGE AFTER POWER OFF. AND THE SERVICE SHOULD BE COMPLETELY CHECKED IS DRAINED.

4.1.4 Performing a Complete Shutdown

1. Turn off the loads connected to the device.
2. Use the front panel to turn the device OFF

Main Menu> Control> Password> Stop

MAKELSAN LEVELUPS 18/07/2012 16.12:47	
300KVA 3/3 SINGLE	
Start	Control
> Stop	
Switch to BYPASS	Status
Switch to UPS	
Battery Quick Test	Setup
Battery Capacity Test	
Stop Battery Test	Logging
	Service
18/07/2012 16.08:22	No Alarm
Normal Mode	

3. Check if the the UPS has switched to bypass mode, via mimic diagram LEDs and LCD panel.
4. Turn OFF respectively the output(CB3), battery (CB4), outer battery (CB5) and input (CB1) .



MAKE SURE THAT THERE ARE NO CRITICAL LOADS ON THE UPS OUTPUT BEFORE PERFORMING A COMPLETE SHUTDOWN.

4.1.5 EPO(Emergency Power OFF)

By pressing the EPO button, the device respectively turns the rectifier, the booster and the inverter OFF. If the output breaker turn off option is set, the UPS completely disconnects from the system.

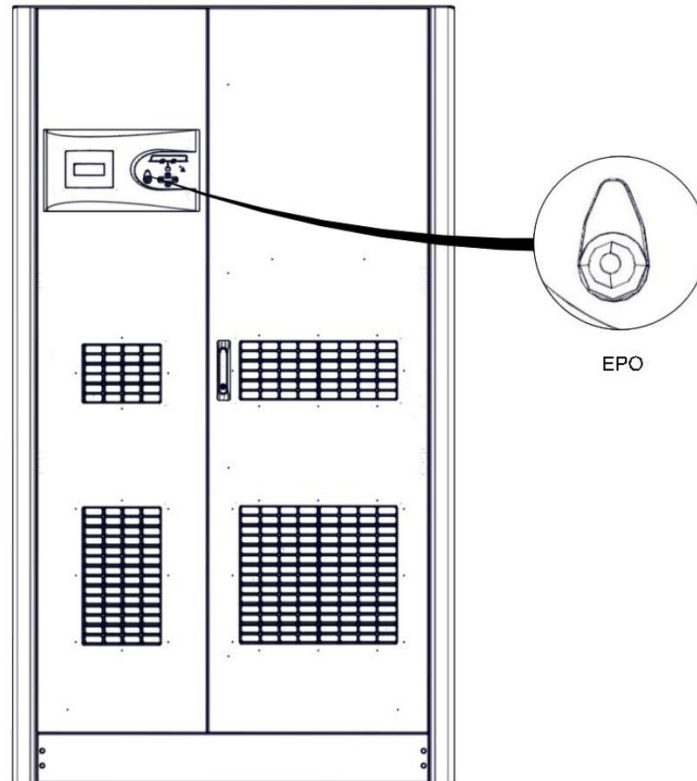

4.1.6 RS232 Serial Communication Installation and Investigation

LevelUps series has an RS-232 interface which supports SEC and TELNET protocol as standard. This interface is fully isolated and safe. UPS can be monitored remotely via a computer (PC) or SNMP by using this protocol. This connection works with all kinds of options.

5 EXPLANATIONS of LOGGING

UPS will beep when any problem is detected. You can see the first information about the situation on the front monitor panel. This may not be enough most of the time. In this case, you can see the following warnings by using log screen.

No	Event	Explanations
1	RS232 Start Command	UPS was started by RS232 communication software.
2	RS232 Stop Command	UPS was stopped by RS232 communication software.
3	Auto Restart	After the batteries discharge totally, UPS restarted itself automatically after the mean time which adjusted that follows the mains getting back to normal values.
4	UPS Startup	The main board of the UPS is energized.
5	Soft Start Fail	UPS could not ramp the DC bus up.
6	Quick Battery Test	Quick battery test has begun.
7	Deep Battery Test	Battery capacity test has begun.
8	Battery Self Test	Periodical battery test has begun.
9	End Of Discharge	Batteries' voltage has gone below cut off voltage value while UPS was operating on the battery mode.
10	Overload Timeout	UPS has operated at overload more than time limit adjusted. The Loads will be transferred to bypass line.
11	End of Battery Test	Battery test has completed. You can see the all results via front panel status menu..
12	Batt. Test Aborted	Test was aborted manually or by UPS since the criteria was not provided during battery test.
13	Manuel Switch To BYP	Static switches directions were changed manually to the bypass line via UPS command menu.
14	No Battery	No battery detected.
15	Maint. BYP. Sw. On	Maintenance bypass switch has been activated.
16	Ambient Abnor. Temp.	The ambient temperature is over limit. Check the ventilation of UPS room.
17	Inverter Overtemp.	Inverter's temperature is out of limit, in case of 5 degrees more increment ,Load will be transferred to Bypass line.
18	PFC Overtemp.	Rectifier 's temperature is out of limit, in case of 5 degrees more increment ,Load will be transferred to Bypass line.
19	STS Overtemp.	Static Transfer Switches' temperatures are out of limits.UPS will be stopped.
20	Outp.PL1 Cur. Limit.	Short circuit protection is activated for output L1 phase.
21	Outp.PL2 Cur. Limit.	Short circuit protection is activated for output L2 phase.
22	Outp.PL3 Cur. Limit.	Short circuit protection is activated for output L3 phase.

23	Bypass Voltage Bad	Bypass voltage value is out of limit while UPS was operating on the bypass mode. UPS will switch to normal mode if temperature and load status are normal. If not, UPS will stop.
24	Bypass Freq. Bad	Bypass frequency value is out of limit while UPS was operating on the bypass mode. UPS will switch to normal mode if temperature and load status are normal. If not, UPS will stop.
25	Coil Overtemp	Over temperature is observed for UPS' inverter and rectifier coils.
26	Inverter Voltage Bad	Inverter voltage is out of limit. Load will be transferred to bypass line ,when inverter voltage gets back to normal values, UPS will switch to normal mode again.
27	Overload	Output load value is over %105, overloading counter will start to count , If UPS is on normal mode , the charging will be stopped until load value gets back to normal.
28	Maint. BYP. Sw. Off	Maintenance bypass switch is deactivated.
29	Ambient Nor. Temp.	UPS ambient temperature has got back to allowed limit values.
30	Mains Voltage Nor.	Mains voltage is in the limited values , UPS will switch to normal mode.
31	Inverter Nor. Temp.	Inverter temperature is in the limited values .If load and temperature values are normal, UPS will switch to normal mode.
32	PFC Nor. Temp.	Rectifier temperature is in the limited values .If load and temperature values are normal, UPS will switch to normal mode.
33	Charger Nor. Temp.	Charger/booster module temperature is in the allowed limits , charging will be activated again.
34	STS Nor. Temp.	Temperature of Static transfer switches is in the allowed limit.
35	Bypass Voltage Nor.	Bypass voltage is within defined limits.
36	Bypass Freq. Nor.	Bypass frequency is within defined limits.
37	Coil Normal temp.	UPS inverter or rectifier coil temperature has got back to normal values.
38	Inverter Volt. Norm.	Inverter voltage is in the limited values , UPS will switch to normal mode.
39	Normal Load	Output load is under %100 , If charging was OFF , It will be ON .
40	BYP Thyr.L1 Short C.	UPS has detected short circuit at bypass L1 thyristor. UPS will shut down.
41	BYP Thyr.L2 Short C.	UPS has detected short circuit at bypass L2 thyristor. UPS will shut down.
42	BYP Thyr.L3 Short C	UPS has detected short circuit at bypass L3 thyristor. UPS will shut down.
43	UPS Thyr.L1 Short C.	UPS has detected short circuit at inverter L1 thyristor. UPS will shut down.
44	UPS Thyr.L2 Short C.	UPS has detected short circuit at inverter L2 thyristor. UPS will shut down.
45	UPS Thyr.L3 Short C.	UPS has detected short circuit at inverter L3 thyristor. UPS will shut down.
46	UPS Thyr.L1 Open C.	UPS has detected that inverter L1 thyristor cannot be activated. Load will be transferred to bypass line.

47	UPS Thyr.L2 Open C.	UPS has detected that inverter L2 thyristor cannot be activated. Load will be transferred to bypass line.
48	UPS Thyr.L3 Open C.	UPS has detected that inverter L3 thyristor cannot be activated. Load will be transferred to bypass line.
49	BYP Thyr.L1 Open C.	UPS has detected that bypass L1 thyristor cannot be activated. Load will be transferred to inverter line.
50	BYP Thyr.L2 Open C.	UPS has detected that bypass L2 thyristor cannot be activated. Load will be transferred to inverter line.
51	BYP Thyr.L3 Open C.	UPS has detected that bypass L3 thyristor cannot be activated. Load will be transferred to inverter line.
52	Parl. Phs. Rot. Err.	One or more of UPSs which operate in parallel mode do not match in phase sequence.
53	Battery Start	Starting through battery command has been given to UPS .
54	Parl. Start Error	One or more of UPSs which operate in parallel mode could not start to operate.
55	Inverter Fault	UPS couldn't prepare the inverter voltage.
56	Output Off	Static transfer switches all disabled. The loads cannot be energized.
57	Normal Mode	UPS is operating in the normal mode, load are energized through rectifier – inverter line.
58	Battery Mode	UPS is operating in the battery mode, load are energized through battery – inverter line.
59	Bypass Mode	UPS is operating in the bypass mode, load are energized through bypass line.
60	Maint. Bypass Mode	UPS is operating in the maintenance bypass mode,load are energized through maintenance bypass line.
61	Parallel Mode	2 or more UPS are operating in power sharing mode. Load is fed through UPSs' inverter lines.
62	Test Mode	UPS has switched to battery test mode, loads are energized through rectifier-battery- inverter line as source sharing.
63	Manual Switch to UPS	Switching to inverter(normal) mode command has been given via front panel.
64	Output Voltage Error	Output voltage is detected during the period of starting UPS .UPS has been stopped.
65	PFC Stop Cmd.	Abnormal situation is detected during the moment of rectifier operating.UPS has stopped itself.
66	Manuel Start Command	Start command is given via UPS command menu.
67	Manuel Stop Command	Stop command is given via UPS command menu.
68	UPS Stopped	UPS has been stopped.
69	Bypass Problem	UPS has switched to bypass mode so many times in a short period,UPS will be shut down.
70	Parameters Changed	Device-related parameters were changed on the service menu
71	Batteries Changed	Battery replacement date has been changed. Battery statistics will be reset.
72	Load impact Transfer	The load which cannot be handled by inverter is activated. Loads will be transferred to bypass line.

73	Parallel Command	UPS which is operating in parallel mode has been given a command to change the status of static switches.
74	No P.CAN Bus Comm.	Slave UPS which is operating in parallel mode can't reach to master UPS from CAN bus. If UPS is operating, will be shut down.
75	Ext. Start Command	UPS which is operating in parallel mode has been given a command to start up by another (master) UPS.
76	Ext. Stop Command	UPS which is operating in parallel mode has been given a command to stop by another (master) UPS.
77	Ext. Switch To BYP.	UPS which is operating in parallel mode has been given a command to transfer the load to bypass line.
78	Ext. Switch To UPS	UPS which is operating in parallel mode has been given a command to transfer the load to inverter line.
79	Parallel Comm. FE.	Slave UPS which is operating in parallel mode has detected a failure of input current sharing.
80	Inverter OKEY	Inverter voltage reached needed value after UPS is started up. UPS can feed the loads through inverter.
81	Batt. Temp. Err.	Battery temperature is out of defined limits, batteries can be damaged.
82	EPO key pressed	EPO key button is pressed.
83	Battery Low	Battery capacity has decreased below defined " battery low limit" while UPS was operating in battery mode.
84	No P.485 Bus Comm.	Parallel RS485 communication between the systems is not available.
85	STS Over Current	Over Current in Bypass line.
86	BYP. Phase Rot. Err.	Reverse phase sequence was detected in mains at the UPS run time.
87	Output DC Volt. Fault	Over Inverter DC voltage. Loads will be transferred to the bypass line.
88	Output Offset Err.	One or more phase of slave UPS' output is not connected to master UPS in Parallel systems.
89	Battery Temp. Nor.	Battery temperature is normal.
90	PFC Pbus OverVoltage	Positive DC Bus overvoltage.
91	PFC Nbus OverVoltage	Negative DC Bus overvoltage
92	PFC PhL1 OverCurrent	Short circuit protection is activated for rectifier L1 phase.
93	PFC PhL2 OverCurrent	Short circuit protection is activated for rectifier L2 phase.
94	PFC PhL3 OverCurrent	Short circuit protection is activated for rectifier L3 phase.
95	Single Stop	Command to stop itself has been given to UPS which is operating in parallel mode separately from parallel system.
96	Master Changed	UPS became master device in parallel system.
97	Par.Bus ID Collision	ID value of one or more UPS is the same as each other in parallel system.
98	Stop All Units	Stop all units command was given via front panel.
99	Pwr. Supply Fault	The error signal is detected on UPS through power source circuit debugger.
100	Generator Mode	Signal is detected from "generator mode input" of dry contact board. UPS will switch to "generator mode".

6 Table of Technical Specifications

Technical Specifications						
Power	300kVA	300kVA	400kVA	400kVA	500kVA	500kVA
PF	1	0,9	1	0,9	1	0,9
Active Power	300kW	270kW	400kW	360kW	500kW	450kW
Input						
Input Voltage Range	220/380 VAC - %15 + %18 3P + N + PE					
Input Power Factor	At Full Load > 0,99					
Input Frequency Range	45-65 Hz (Selectable)					
Rectifier	IGBT Rectifier					
Total Harmonic Distortion (THDi)	<%4					
Output						
Output Voltage Range	220/380 VAC 3P + N \pm 1% Static, \pm 1% Dynamic					
Recovery	At 0% - 100% - 0% load, maximum output tolerance %5, %1 Back to band <40ms.					
Efficiency	Up to %96					
Output Frequency Range	50Hz \pm 0,5% synchronous with the network,				50Hz \pm 0,2% Battery Mode	
Output THD (THDv)	Linear Load <%2					
	Non-Linear Load <%6					
Crest Factor (CF)	3:1					
Overload Capacity	At %125 load 10 min. , at %150 load 1 min.					
Protections	The input voltage is out of tolerance, input frequency is out of tolerance, input phase failure, output voltage is out of tolerance, output frequency is out of tolerance, output phase failure, DC component that can occur at the output voltage, Overload that will occur at the output (out of the periods specified), Overheating that will cause failure related to over temperature, high voltage which will occur at DC Bus voltage, low voltage which will occur at DC Bus voltage, short circuit at the output.					

Battery			
Quantity (12V DC VRLA)	60 (2 group of 30 Ah independent battery)		
Charge Value (C)	Nominal 0,1 C, adjustable		
Battery Power	25% of the device power		
Communication			
Communication Port	RS232 Standard, RS485 and SNMP Adapter option		
Dry Contact	Optional		
Protocol	SEC, TELNET		
Certificates			
Quality	ISO 9001		
Safety	IEC 62040-1, IEC 60950		
EMC/LVD	IEC 62040-2		
General			
Running Temperature	For UPS 0 °C ~40 °C For Battery 0 ~ 25 °C)		
Storage Temperature	For UPS -15 °C ~ 45 °C For Batteries-10 ~ 60°C)		
Protection Class	IP20		
Chassis	Anti-Static Paint Protection		
Humidity	0-95 %		
Altitude	<1000m, Correction Factor 1. <2000m, Correction Factor >0,92, <3000m; Correction Factor >0,84		
Alerts	500Event Log. (Optional Status Record)		
Parallel Operation	Parallel power increase up to 8 pcs.		
EPO (Emergency Power Off)	Standard		
Isolation Transformer	Optional		
Net Weight t (kg)	850	850	850
Dimensions (W x D x H)mm	1200x845x2104,5mm		

7 CONTACT INFORMATIONS

MAKELSAN®
Uninterruptible Power Supplies

www.makelsan.com.tr

Headquarter: İstanbul Deri Organize Sanayi Bölgesi 2. Yol I -5 Parsel 34956 Tuzla/
İstanbul

Phone : +90 216 428 65 80
Fax : +90 216 327 51 64
E-mail : makelsan@makelsan.com.tr

İzmir Office : Halkapınar Mah. 1348 Sok. 2AE Keremoğlu İş Merkezi Yenişehir - İzmir

Tel : +90 232 469 47 00
Fax : +90 232 449 47 00
E-mail : izmir@makelsan.com.tr

Ankara Office : Mustafa Kemal Mah. 2157 Sok. No:4/6 Çankaya-Ankara

Tel : +90 312 219 82 35/37
Fax : +90 312 219 82 36
E-mail : ankara@makelsan.com.tr

Technical service:

Phone: +90 216 428 65 80
+90 216 327 51 64
E-mail: teknik.servis@makelsan.com.tr

MAKELSAN®

Uninterruptible Power Supplies

www.makelsan.com.tr

Headquarter: İstanbul Deri Organize Sanayi Bölgesi 2. Yol I -5 Parsel 34956 Tuzla/İstanbul

Phone : +90 216 428 65 80

Fax : +90 216 327 51 64

E-mail : makelsan@makelsan.com.tr

İzmir Office : Halkapınar Mah. 1348 Sok. 2AE Keremoğlu İş Merkezi Yenişehir - İzmir

Tel : +90 232 469 47 00

Fax : +90 232 449 47 00

E-mail : izmir@makelsan.com.tr

Ankara Office : Mustafa Kemal Mah. 2157 Sok. No:4/6 Çankaya-Ankara

Tel : +90 312 219 82 35/37

Fax : +90 312 219 82 36

E-mail : ankara@makelsan.com.tr

Technical service:

Phone : +90 216 428 65 80

: +90 216 327 51 64

E-mail : teknik.servis@makelsan.com.tr